

ARTESYN DS1200HE-3 SERIES

1200 Watts Distributed Power System



PRODUCT DESCRIPTION

Advanced Energy's DS1200 series is Artesyn Embedded Power highest power, highest density bulk front end AC-DC power supply in the industry standard 1U x 2U form factor. It accepts a wide range 90 to 264Vac input and provides a main 12V output plus a 3.3V or optional 5.5V standby output. Rated at 1100 watts, it has a high half-load efficiency of 91%. Housed in an industry standard 1U x 2U rack-mounting package, the power supply is designed for servers and similar space-constrained applications. This series comes in two airflow versions — dc-connector to ac-connector and vice versa.

SPECIAL FEATURES

- 1200W output power
- 1U x 2U power supply
- High power
- Active power factor correction
- High-density design: 21.66W/in³
- EN61000-3-2 harmonic compliance
- Inrush current control
- 80PLUS Platinum efficiency
- Full digital control
- N+N, N+1 redundant
- Hot-pluggable
- Active current sharing
- Input power reporting
- Compatible with Artesyn's Universal PMBus™ GUI
- Reverse airflow option
- Two years warranty

SAFETY

- UL/cUL60950 (UL Recognized)
- Nemko+CB Report EN60950
- CE Mark
- China CCC

TYPICAL APPLICATIONS

- Industrial

AT A GLANCE

Total Power:

1000 to 1200 Watts

Input Voltage:

90 to 264 Vac

of Outputs:

Main and Standby



MODEL NUMBERS

Standard	Output Voltage	Minimum Load	Maximum Load	Stand-By Supply	Air Flow Direction
DS1200HE-3	12.0Vdc	0A	100A	3.3V@6A	Normal (DC Connector to Handle)
DS1200HE-3-002	12.0Vdc	0A	100A	5V@4A	Normal (DC Connector to Handle)
DS1200HE-3-003	12.0Vdc	0A	100A	3.3V@6A	Reversed (Handle to DC Connector)
DS1200HE-3-004	12.0Vdc	0A	100A	5V@4A	Reversed (Handle to DC Connector)

Options

None

ELECTRICAL SPECIFICATIONS

Absolute Maximum Ratings

Stress in excess of those listed in the “Absolute Maximum Ratings” may cause permanent damage to the power supply. These are stress ratings only and functional operation of the unit is not implied at these or any other conditions above those given in the operational sections of this TRN. Exposure to any absolute maximum rated condition for extended periods may adversely affect the power supply’s reliability.

Table 1. Absolute Maximum Ratings						
Parameter	Models	Symbol	Min	Typ	Max	Unit
Input Voltage AC continuous operation	All models	$V_{IN,AC}$	90	-	264	Vac
Maximum Output Power (Main + Stand-by) $V_{IN,AC} > 180Vac$	All models	$P_{O,max}$	-	-	1200	W
Maximum Output Power (Main + Stand-by) $V_{IN,AC} \pm 180Vac$	DS1200HE-3 DS1200HE-3-002 DS1200HE-3-003 DS1200HE-3-004	$P_{O,max}$	- - - -	- - - -	1000 1000 1200 1200	W
Isolation Voltage						
Input to outputs	All models		-	-	2121	Vdc
Input to safety ground	All models		-	-	2121	Vdc
Output to safety ground	All models		-	-	50	Vdc
Ambient Operating Temperature ¹	All models	T_A	-10	-	70	°C
Storage Temperature	All models	T_{STG}	-40	-	85	°C
Humidity (non-condensing)						
Operating	All models		10	-	90	%
Non-operating	All models		10	-	95	%
Altitude						
Operating	All models		-	-	10000	Feet
Non-operating	All models		-	-	50000	Feet

Note 1 - With power derating (see page 23 power derating curve).

ELECTRICAL SPECIFICATIONS

Input Specifications

Table 2. Input Specifications						
Parameter	Condition	Symbol	Min	Typ	Max	Unit
Operating Input Voltage, AC	All	$V_{IN,AC}$	90	115/230	264	Vac
Input AC Frequency	All	$f_{IN,AC}$	47	50/60	63	Hz
Maximum Input Current ($I_O = I_{O,max}$, $I_{SB} = I_{SB,max}$)	$V_{IN,AC} = 90Vac$	$I_{IN,max}$	-	-	15	A
Standby Input Current ($V_O = \text{Off}$, $I_{SB} = 0A$)	$V_{IN,AC} = 90Vac$ $V_{IN,AC} = 180Vac$	$I_{IN,Standby}$	- -	- -	200 300	mA
Standby Input Power ($V_O = \text{Off}$, $I_{SB} = 0A$)	All	$P_{IN,Standby}$	-	-	4	W
No Load Input Current ($V_O = \text{On}$, $I_O = 0A$, $I_{SB} = 0A$)	$V_{IN,AC} = 90Vac$ $V_{IN,AC} = 180Vac$	$I_{IN,no-load}$	- -	- -	400 300	mA
Harmonic Line Currents	All	THD	Per IEC61000-3-2			
Power Factor	All	PF	-	0.90	-	
Startup Surge Current (Inrush) @ 25°C	$V_{IN,AC} = 264Vac$	$I_{IN,surge}$	-	-	55	A
Input Fuse	Internal, L and N 5x20mm, Quick Acting 16A, 250V		-	-	16	A
Leakage Current to Earth Ground	$V_{IN,AC} = 240Vac$ $f_{IN,AC} = 50/60Hz$		-	-	1.4	mA
PFC Switching Frequency	All	$f_{SW,PFC}$	90	-	110	KHz
Operating Efficiency @ 25°C	$I_O = 50\%I_{O,max}$ $V_{IN,AC} = 115Vac$ $V_{IN,AC} = 230Vac$	η	-	-	91.0	%
			-	-	94.0	%
System Stability	Phase Margin Gain Margin		45			\emptyset
			6	-	-	dB

ELECTRICAL SPECIFICATIONS

Output Specifications

Table 3. Output Specifications							
Parameter		Condition	Symbol	Min	Typ	Max	Unit
Output Regulation	All models	Inclusive of set-point, temperature change, warm-up drift and dynamic load	V_O	11.4	12.0	12.6	V
	DS1200HE-3 DS1200HE-3-003		V_{SB}	2.97	3.30	3.63	V
	DS1200HE-3-002 DS1200HE-3-004		V_{SB}	4.50	5.00	5.50	V
Output Ripple, pk-pk	All models	Measure with a 0.1 μ F ceramic capacitor in parallel with a 10 μ F tantalum capacitor, 0 to 20MHz bandwidth	V_O	-	-	120	mV _{PK-PK}
	DS1200HE-3 DS1200HE-3-003 DS1200HE-3-002 DS1200HE-3-004		V_{SB}	-	-	50	mV _{PK-PK}
Output Current	All models	$V_{IN,AC} > 180Vac$	I_O	0	-	100	A
	DS1200HE-3 DS1200HE-3-002 DS1200HE-3-003 DS1200HE-3-004	$V_{IN,AC} \leq 180Vac$	I_O	0	-	83.3	A
				0	-	83.3	A
				0	-	100	A
DS1200HE-3 DS1200HE-3-003		I_{SB}	0	-	6.0	A	
DS1200HE-3-002 DS1200HE-3-004		I_{SB}	0	-	4.0	A	
Ripple Switching Frequency		All	$f_{SW,DC-DC}$	560	-	580	KHz
Main Output Current Share Accuracy		40% to 100% $I_{O,max}$ 10% to 40% $I_{O,max}$		-	-	5 20	% I_O % I_O
Minimum Load for Current Sharing				5	-	-	% $I_{O,max}$
Number of Parallel Units		Main output current share connected		-	-	4	Units
Load Capacitance		Start up	C_O	2000	-	40000	μ F
Main Output Dynamic Response		50% load change Slew rate = 1A/ μ s	$\pm\%V_O$ T_s	-	-	5	%
Peak Deviation Settling Time				-	-	-	mSec
Main Output Long Term Stability Max change over 24 hours		After thermal equilibrium (30mins)	$\pm\%V_O$	-	-	0.2	%

Note 1 - V_{SB} output does not use active current sharing. On paralleled units, maximum current on V_{SB} output rail should not exceed the current of one unit.

ELECTRICAL SPECIFICATIONS

DS1200HE-3-002 Performance Curves

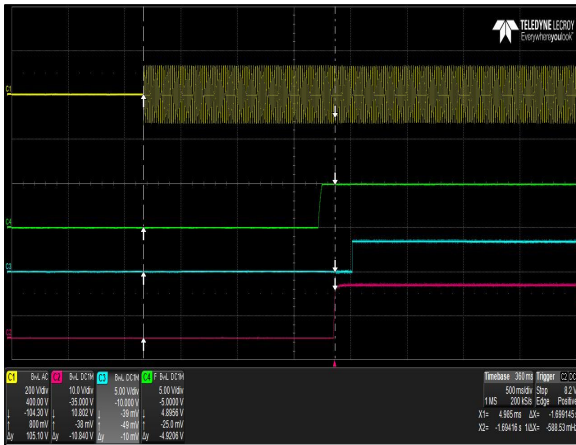

Figure 1: DS1200HE-3-002 Turn-On Delay via AC Mains
 Vin = 90Vac Load: I_O = 83.3A I_{SB} = 4A (5V)
 Ch 1: AC Mains Ch 2: V_O Ch 3: Pwr_GOOD Ch 4: V_{SB}

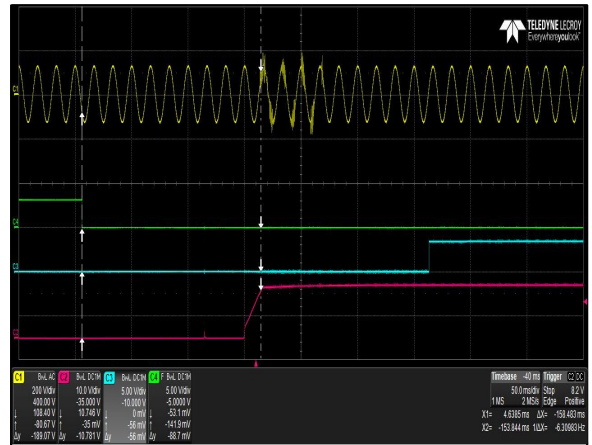

Figure 2: DS1200HE-3-002 Turn-On Delay via PS_ON
 Vin = 90Vac Load: I_O = 62.5A I_{SB} = 4A (5V)
 Ch 1: AC Mains Ch 2: V_O Ch 3: Pwr_GOOD Ch 4: PS_ON

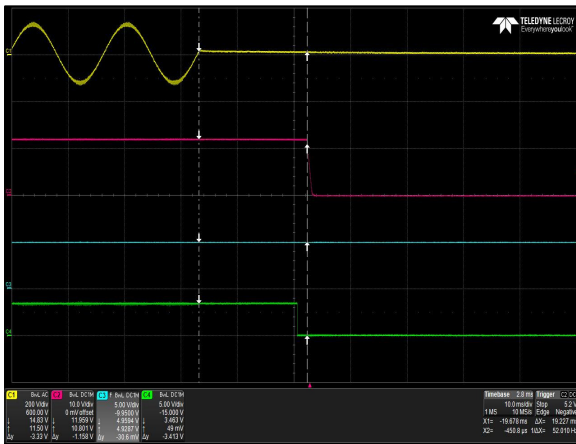

Figure 3: DS1200HE-3-002 Hold-up Time
 Vin = 90Vac Load: I_O = 83.3A I_{SB} = 4A (5V)
 Ch 1: AC Mains Ch 2: V_O Ch 3: V_{SB} Ch 4: Pwr_GOOD

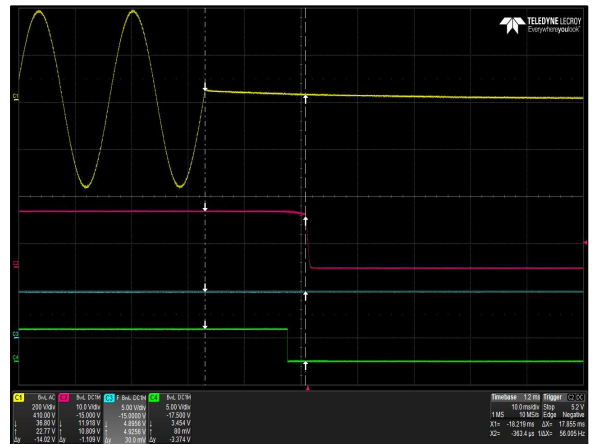

Figure 4: DS1200HE-3-002 Hold-up Time
 Vin = 264Vac Load: I_O = 100A I_{SB} = 4A (5V)
 Ch 1: AC Mains Ch 2: V_O Ch 3: V_{SB} Ch 4: Pwr_GOOD

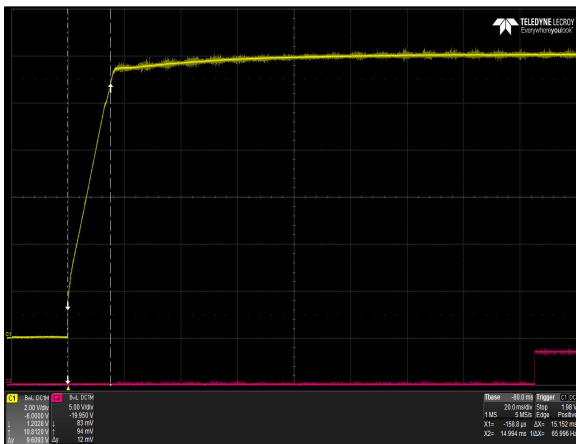

Figure 5: DS1200HE-3-002 Output Voltage Startup Characteristic
 Vin = 90Vac Load: I_O = 83.3A I_{SB} = 4A (5V)
 Ch 1: V_O Ch 2: Pwr_GOOD

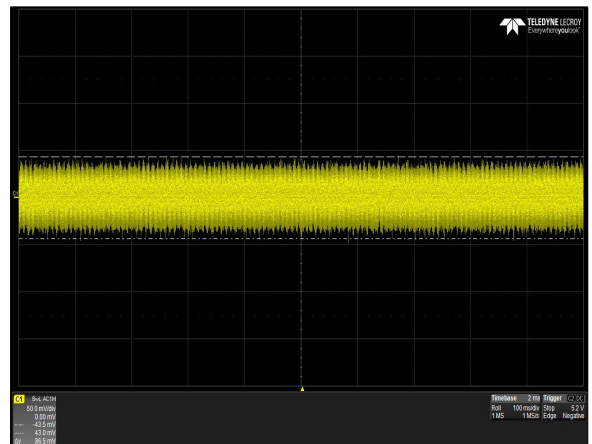

Figure 6: DS1200HE-3-002 Ripple and Noise Measurement
 Vin = 115Vac Load: I_O = 83.3A I_{SB} = 4A (5V)
 Ch 1: V_O

ELECTRICAL SPECIFICATIONS

DS1200HE-3-002 Performance Curves

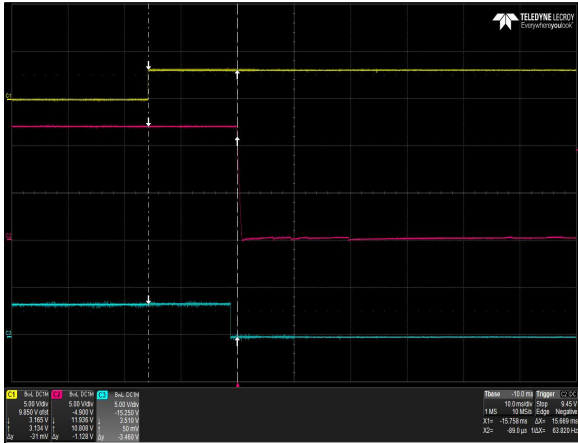

Figure 7: DS1200HE-3-002 Turn Off Characteristic via PS_ON
 Load: $I_O = 81.7A$ $I_{SB} = 4A$ (5V)
 Ch 1: PS_ON Ch 2: V_O Ch 3: Pwr_GOOD

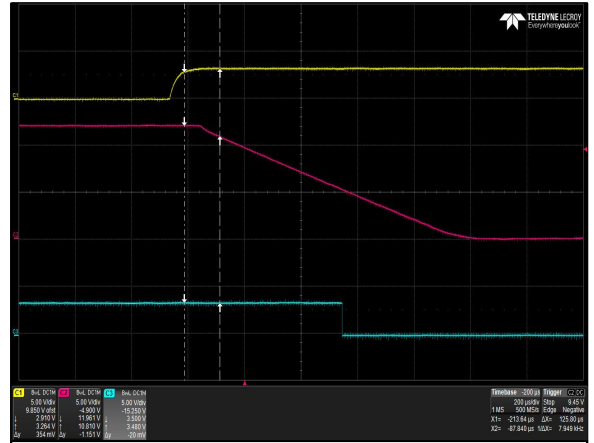

Figure 8: DS1200HE-3-002 Turn Off Characteristic via PS_INHIBIT
 Load: $I_O = 81.7A$ $I_{SB} = 4A$ (5V)
 Ch 1: PS_INHIBIT Ch 2: V_O Ch 3: Pwr_GOOD

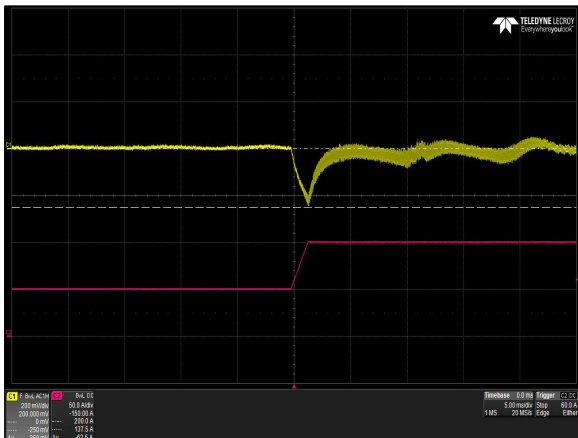

Figure 9: DS1200HE-3-002 Transient Response - V_O Deviation
 50% to 100% load change 1A/uS slew rate $V_{in} = 230Vac$
 Ch 1: V_O Ch 2: I_O

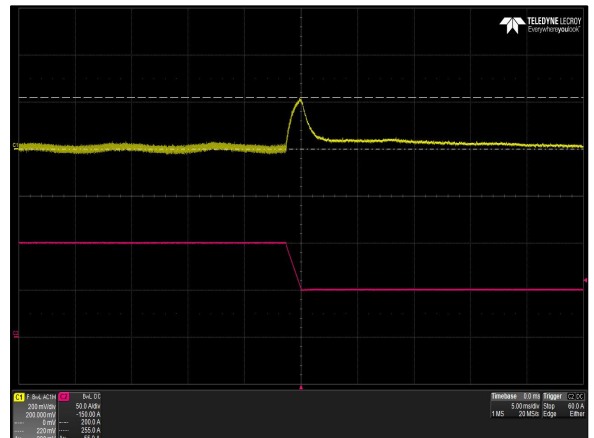

Figure 10: DS1200HE-3-002 Transient Response - V_O Deviation
 100% to 50% load change 1A/uS slew rate $V_{in} = 230Vac$
 Ch 1: V_O Ch 2: I_O

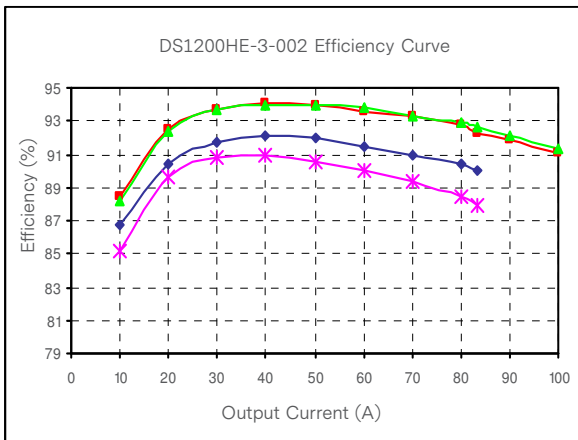

Figure 11: DS1200HE-3-002 Efficiency Curve @ 25°C
 Loading: $I_{o_main} = 10\%I_{o_max}$ increment to 100A, $I_{SB} = 0A$ (5V)

ELECTRICAL SPECIFICATIONS

System Timing Specifications

Table 4. System Timing Specifications					
Label	Parameter	Min	Typ	Max	Unit
T1	Delay from AC being applied to V_{SB} being within regulation.	-	-	1700	mSec
T2	Delay from AC being applied to output voltages being within regulation with PSON_L asserted low.	-	-	2000	mSec
T3	V_O rise time, 0V to V_O in regulation.	3	-	50	mSec
T4	Delay from output voltages within regulation limits to POWER GOOD asserted high.	100	-	1000	mSec
T5	Delay from loss of AC to de-assertion of POWER GOOD.	11	-	-	mSec
T6	Delay from POWER GOOD de-asserted to output voltages dropping out of regulation limits.	1	-	-	mSec
T7	Hold up time - time all output voltages, including V_{SB} , stay within regulation after loss of AC.	12	-	-	mSec
T8	Delay from loss of AC input to ACOK_H going to low.	7	-	14	mSec
T9	Duration of POWER GOOD being in the de-asserted state during an off/on cycle using AC or the PSON_L signal.	100	-	-	mSec
T10	Delay from PSON_L active to output voltages within regulation limits.	-	-	350	mSec

ELECTRICAL SPECIFICATIONS

System Timing Diagram

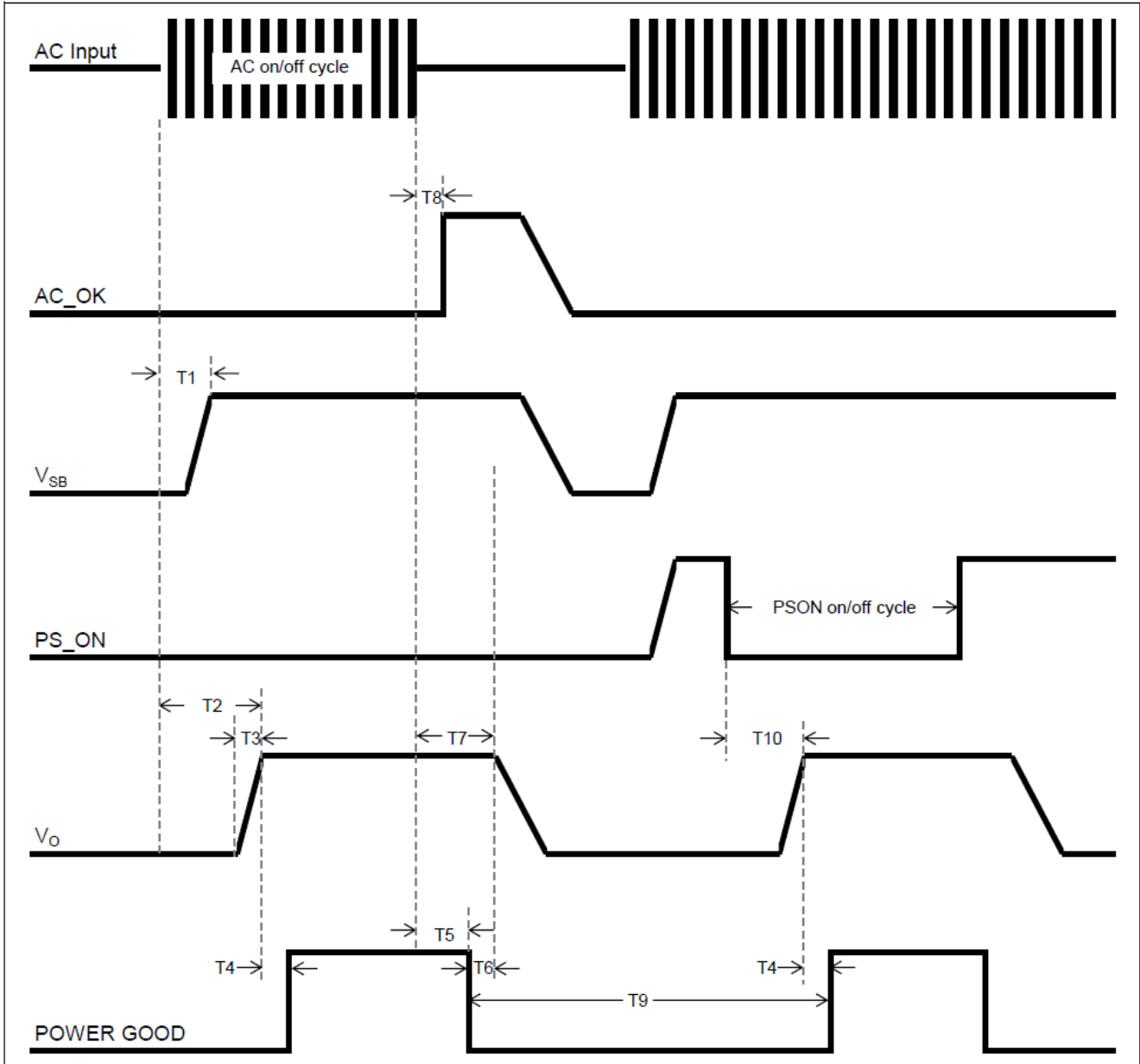

ELECTRICAL SPECIFICATIONS

Protection Function Specifications

Input Fuse

DS1200HE-3 series power supply is equipped with an internal non user serviceable 16A High Rupturing Capacity (HRC) 250 Vac fuse to IEC 127 for fault protection in both the L1 and L2 lines input.

Over Voltage / Under Voltage Protection (OVP / UVP)

The power supply latches off during output overvoltage and under voltage with the AC line recycled to reset the latch.

OVP

Parameter	Min	Nom	Max	Unit
V _O Output Overvoltage	13.5	/	15	V
3.3V _{SB} Output Overvoltage	3.63	/	4.29	V
5V _{SB} Output Overvoltage	5.5	/	6.5	V

UVP

Parameter	Min	Nom	Max	Unit
V _O Output Under-voltage	10.5	/	11.0	V

Over Current Protection (OCP)

DS1200HE-3 series power supply includes internal current limit circuitry to prevent damage in the event of overload or short circuit. Recovery must be automatic when the overload is removed, if the overload lasts for 1 second or less, and if it is less than or equal to 120% to 130% of rated load. If the overload is >130% of rated load, the power supply shall latch off immediately. In addition, if the overload fault is presented for longer than 1 second, the power supply will also latch off, requiring AC power or PSON_L recycling to restart the power supply.

Parameter	Input Voltage	Model	Min	Nom	Max	Unit
V _O Output Overvoltage	180-264Vac	All	120	/	150	A
	90-179Vac	DS1200HE-3 DS1200HE-3-002	120	/	150	A
		DS1200HE-3-003 DS1200HE-3-004	99.96	/	124.95	A
3.3V _{SB} Output Overvoltage	90-264Vac	All	7.2	/	9	A
5V _{SB} Output Overvoltage	90-264Vac	All	4.8	/	6	A

ELECTRICAL SPECIFICATIONS

Short Circuit Protection (SCP)

The DS1200HE-3 series power supply will withstand a continuous short circuit with no permanent damage, applied to its main output during start-up or while running. A short circuit is defined as an impedance of 0.1ohms or less.

When the standby output is shorted the output will go into “hiccup mode”. When the standby output attempts to restart, the maximum peak current from the standby output will be less than 9.0A peak (3.3V) or 6.6A (5.0V). The maximum average current, taking into account the “hiccup” duty cycle, is less than 4.9A (3.3V) or 3.3A (5.0V).

Over Temperature Protection (OTP)

The power supply is internally protected against over temperature conditions. When the OTP circuit is activated, the power supply will latch off, requiring AC power or PS_ON recycling to restart the power supply.

MECHANICAL SPECIFICATIONS

Mechanical Outlines (unit: mm)

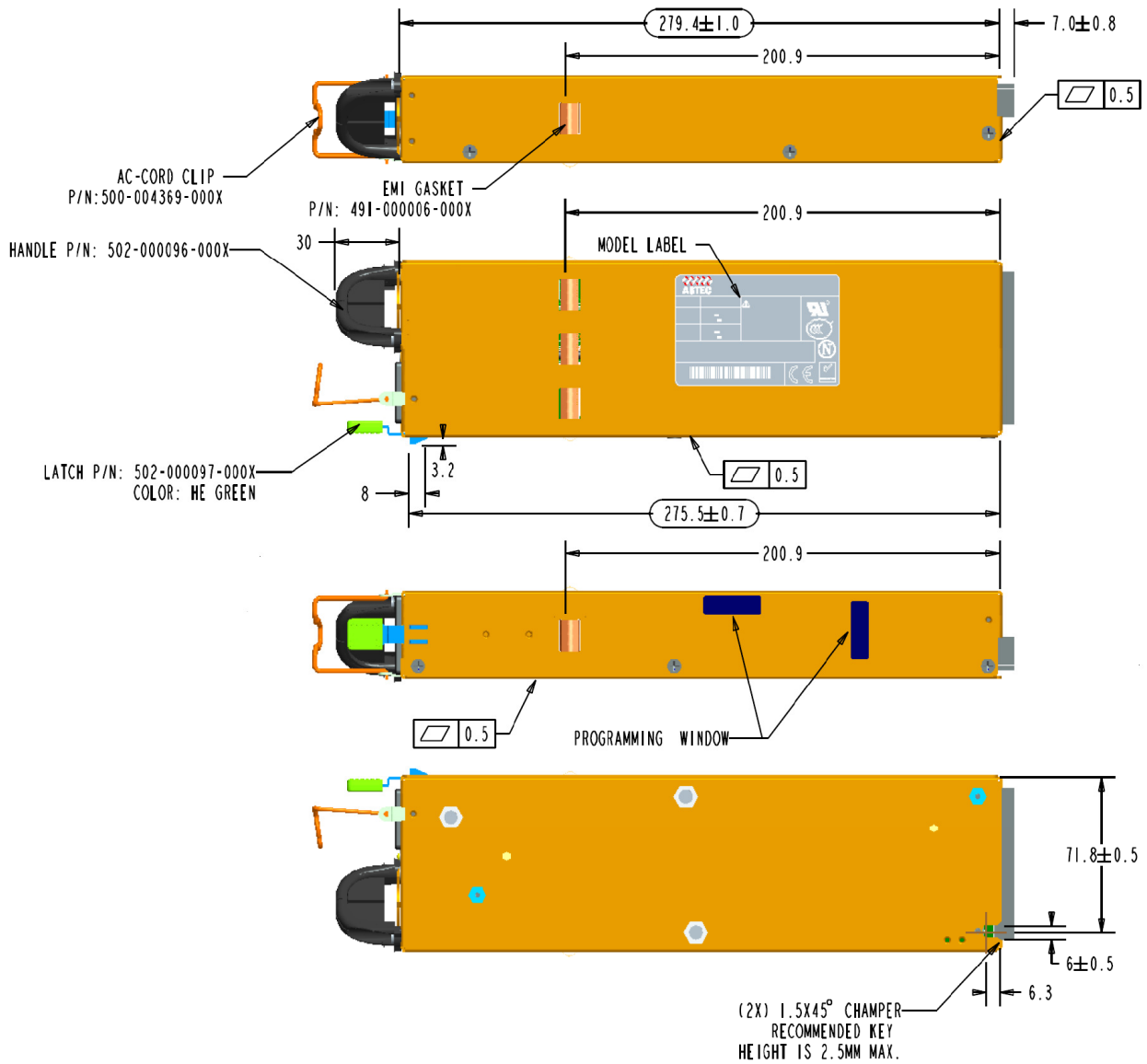

MECHANICAL SPECIFICATIONS

Mechanical Outlines (unit: mm)

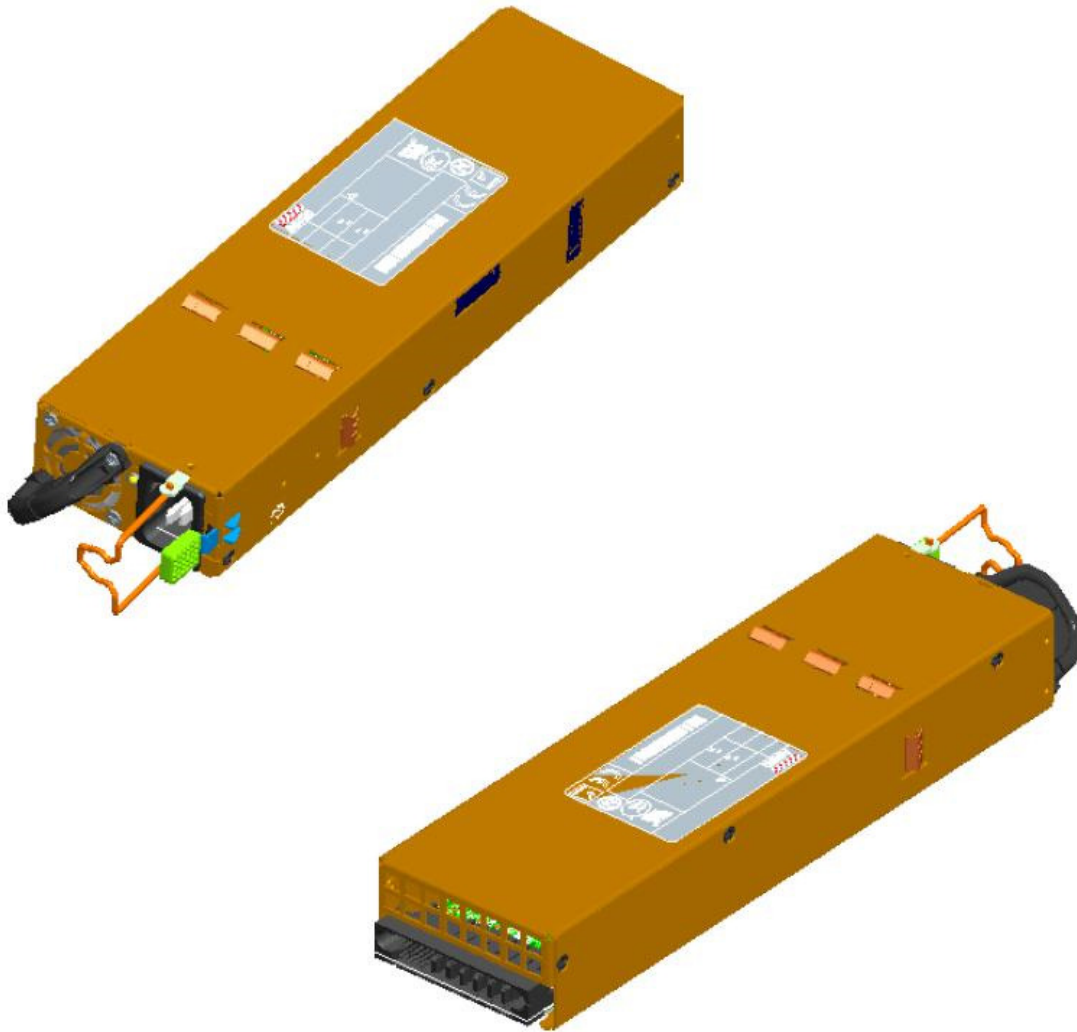
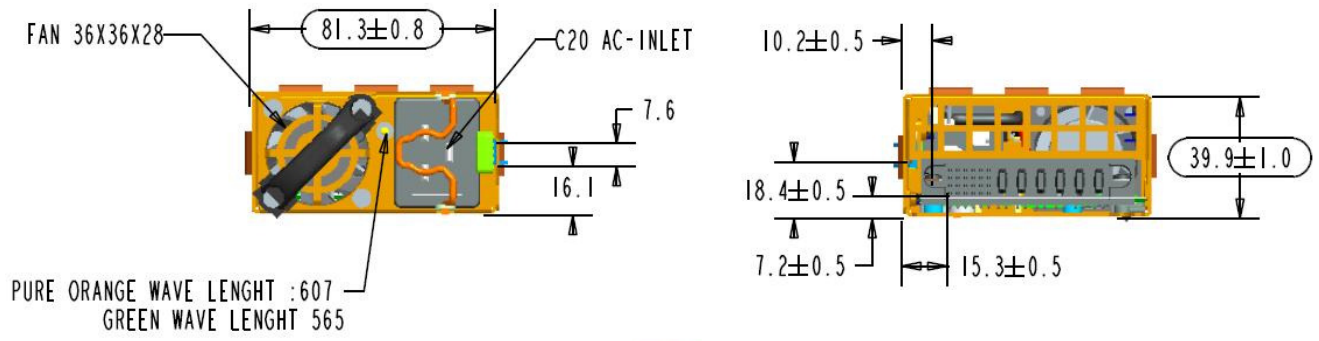

MECHANICAL SPECIFICATIONS

Connector Definitions

AC Input Connector

Pin 1 – L1

Pin 2 – L2

Pin 3 – Earth Ground

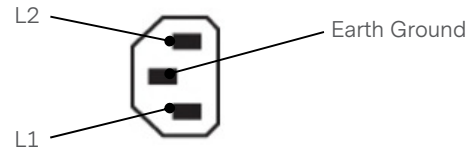

Output Connector - Power Blades

PB1 – Main Output Return

PB2 – Main Output Return

PB3 – Main Output Return

PB4 – + Main Output (V_O)

PB5 – + Main Output (V_O)

PB6 – + Main Output (V_O)

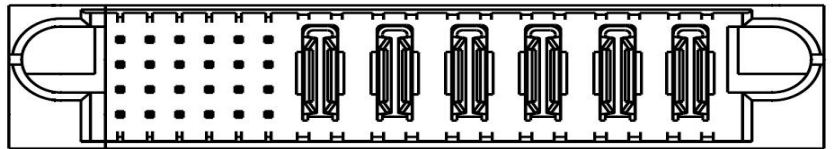

View from power supply output connector end

Output Connector - Control Signals

- A1 – PSON_L
- A2 – Main output remote sense return, VSENSE-
- A3 – SPARE
- A4 – PS_PRESENT
- A5 – STAND-BY, +VSB
- A6 – STAND-BY RETURN, -VSB
- B1 – ACOK_H (AC Input Present)
- B2 – Main output remote sense, VSENSE+
- B3 – ISHARE
- B4 – PS_INHIBIT/PSKILL
- B5 – STAND-BY, +VSB
- B6 – STAND-BY RETURN, -VSB
- C1 – SDA (I²C Data Signal)
- C2 – SCL (I²C Clock Signal)
- C3 – POWER GOOD/ PWOK_H
- C4 – SPARE
- C5 – STAND-BY, +VSB
- C6 – STAND-BY RETURN, -VSB
- D1 – A0 (I²C Address BIT 0 Signal)
- D2 – A1 (I²C Address BIT 1 Signal)
- D3 – PS_INTERRUPT (Alarm)
- D4 – STAND-BY RMT SENSE, VSENSE_STBY
- D5 – STAND-BY, +VSB
- D6 – STAND-BY RETURN, -VSB

D1	D2	D3	D4	D5	D6	PB1	PB2	PB3	PB4	PB5	PB6
C1	C2	C3	C4	C5	C6						
B1	B2	B3	B4	B5	B6						
A1	A2	A3	A4	A5	A6						

MECHANICAL SPECIFICATIONS

Power / Signal Mating Connectors and Pin Types

Table 5. Mating Connectors for DS1200HE-3 Series		
Reference	On Power Supply	Mating Connector or Equivalent
AC Input Connector	IEC320-C13	IEC320-C19
Output Connector	FCI Power Blade 51721 series 51721-10002406AA or Molex Power Connector SD-87667 series 87667-7002	FCI Power Blade 51741-10002406CC Straight Pins
		FCI Power Blade 51761-10002406AALF Right Angle
		Any other approved equivalent

MECHANICAL SPECIFICATIONS

LED Indicator Definitions

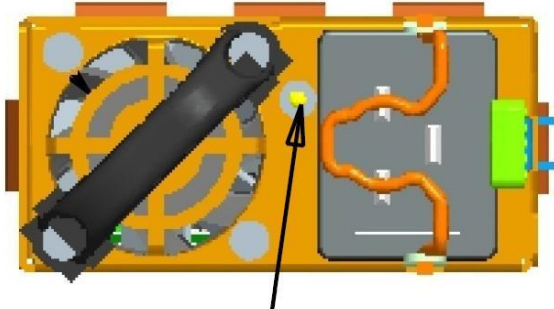

Status LED

One bi-color (green/amber) LED at the power supply front provides the status signal. The status LED conditions are shown on the below table.

Conditions	LED Status
$V_{SB} = ON, V_O = OFF, AC\ Input = ON$	Blinking Green
$V_{SB} = ON, V_O = ON$	Solid Green
$V_O = OVP / UVP$	Blinking Amber
Power Supply Failure (OCP / OTP / FAN_FAULT)	Solid Amber

MECHANICAL SPECIFICATIONS

Weight

The DS1200HE-3 series power supply weight is 1.34kg/2.95lbs maximum.

ENVIRONMENTAL SPECIFICATIONS

EMC Immunity

DS1200HE-3 series power supply is designed to meet the following EMC immunity specifications.

Table 6. Environmental Specifications	
Document	Description
FCC Part 15 Subpart J Class B / EN55032, Level B	Conducted and Radiated EMI Limits
EN61000-3-2	Harmonic
EN61000-3-3	Voltage Fluctuations
IEC/EN61000-4-2	Electromagnetic Compatibility (EMC) - Testing and measurement techniques - Electrostatic discharge immunity test: +/-15KV air, +/-8KV contact discharge. Performance - Criteria B
IEC/EN61000-4-3	Electromagnetic Compatibility (EMC) - Testing and measurement techniques - Radiated, radio-frequency, 80-1000MHz, 10V/m, AM 80% (1KHz), 900MHz, 10V/M, PM 100% (200Hz) electromagnetic field immunity test: Performance - Criteria A
IEC/EN61000-4-4	Electromagnetic Compatibility (EMC) - Testing and measurement techniques - Electrical fast transient/burst immunity test: 2KV for AC power port. Performance - Criteria B 1KV for DC ports, I/O and signal ports. Performance - Criteria B
IEC/EN61000-4-5	Electromagnetic Compatibility (EMC) - Testing and measurement techniques - Surge test: 2KV common mode and 1KV differential mode for AC ports and 0.5KV differential mode for DC power, I/O and signal ports. Performance - Criteria B
IEC/EN61000-4-11	Electromagnetic Compatibility (EMC) - Testing and measurement techniques - Voltage dips and interruptions: Criteria A: >95% reduction for 10ms; Criteria B: >30% reduction for 500mS, or Criteria C: >95% reduction for 5000mS.
EN55024	Information Technology Equipment - Immunity Characteristics, Limits and Method of Measurements

ENVIRONMENTAL SPECIFICATIONS

Safety Certifications

The DS1200HE-3 series power supply is intended for inclusion in other equipment and the installer must ensure that it is in compliance with all the requirements of the end application. This product is only for inclusion by professional installers within other equipment and must not be operated as a stand alone product.

Table 7. Safety Certifications for DS1200HE-3 Series Power Supply		
Document	File #	Description
UL60950	E132002-A314-UL-X1	US and Canada Requirements
CSA 22.2 No. 60950	E132002-A314-UL-X1	Information Technology Equipment - Safety - Part 1: General Requirements (Bi-National standard, with UL 60950-1)
EN60950	D-03011-M1	European Requirements
EN60950 Deviations		International Requirements
CB Certificate and Report	DK-35929-UL	(All CENELEC Countries)
CHINA CCC Approval	2013010907665315	China Requirements

ENVIRONMENTAL SPECIFICATIONS

EMI Emissions

The DS1200HE-3 series power supply has been designed to comply with the Class B limits of EMI requirements of EN55022 (FCC Part 15) and CISPR 22 (EN55022) for emissions and relevant sections of EN61000 (IEC61000) for immunity. The unit is enclosed inside a metal box, tested at 1200W using resistive load with cooling fan.

Conducted Emissions

The applicable standard for conducted emissions is EN55022 (FCC Part 15). Conducted noise can appear as both differential mode and common mode noise currents. Differential mode noise is measured between the two input lines, with the major components occurring at the supply fundamental switching frequency and its harmonics. Common mode noise, a contributor to both radiated emissions and input conducted emissions, is measured between the input lines and system ground and can be broadband in nature.

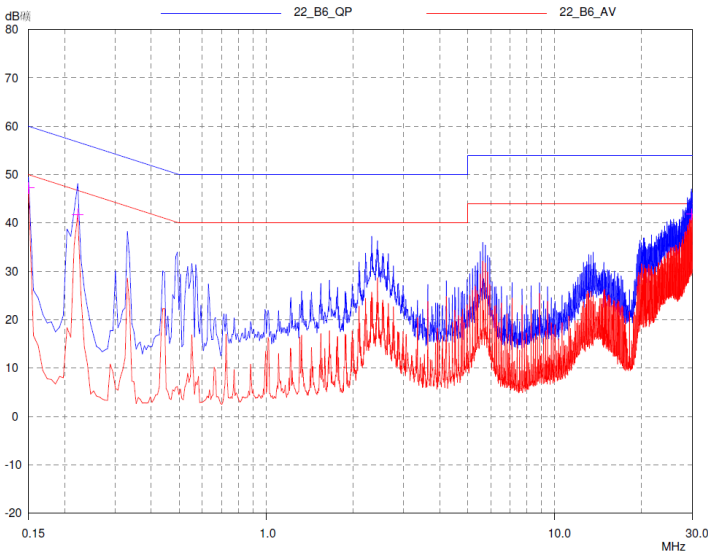

The DS1200HE-3 series power supply has internal EMI filters to ensure the converter’s conducted EMI levels comply with EN55022 (FCC Part 15) Class B and EN55022 (CISPR 22) Class B limits. The EMI measurements are performed with resistive loads at maximum rated loading.

Sample of EN55022 Conducted EMI Measurement at 115Vac input

Note: Blue Line refers to Artesyn Quasi Peak margin, which is 3dB below the CISPR international limit. Red Line refers to the Artesyn Average margin, which is 3dB below the CISPR international limit.

Table 8. Conducted EMI Emission Specifications of The DS1200HE-3 Series Power Supply						
Parameter	Model	Symbol	Min	Typ	Max	Unit
FCC Part 15, class B	All	Margin	-	-	3	dB
CISPR 22 (EN55022), class B	All	Margin	-	-	3	dB

Radiated Emissions

Unlike conducted EMI, radiated EMI performance in a system environment may differ drastically from that in a stand-alone power supply. It is thus recommended that radiated EMI be evaluated in a system environment. The applicable standard is EN55022 Class B (FCC Part 15). Testing AC-DC converters as a stand-alone component to the exact requirements of EN55022 can be difficult because the standard calls for 1m lead to be attached to the input and outputs and aligned such as to maximize the disturbance. In such a set-up, it is possible to form a perfect dipole antenna that very few AC-DC converters could pass. However, the standard also states that an attempt will be made to maximize the disturbance consistent with the typical application by varying the configuration of the test sample.

ENVIRONMENTAL SPECIFICATIONS

Operating Temperature

The DS1200HE-3 series power supplies will start and operate within stated specifications at an ambient temperature from -10°C to 50°C under all load conditions with internal fan. All models can operate up to 70°C with derated power.

Forced Air Cooling

The DS1200HE-3 series power supplies included internal cooling fans as part of the power supply assembly to provide forced air-cooling to maintain and control temperature of devices and ambient temperature in the power supply to appropriate levels. The standard direction of airflow is from the DC connector end to the AC connector end of the power supply.

The cooling fan is a variable speed fan. The fan speed is controlled by the PWM duty cycle of the fan supply voltage depending on the main output 12V load condition per below table:

Fan PWM Duty Cycle	Main Output (12V) Load (A)	
	110Vac	230Vac
100%	81.6	98.4
77%	75.5	93.5
73%	69.4	88.5
62%	63.2	83.6
54%	57.1	78.7
41%	51.0	73.8
38%	44.88 and below	68.9 and below
38%	Stand-by Mode	Stand-by Mode

ENVIRONMENTAL SPECIFICATIONS

Power Derating Curves

DS1200HE-3 and DS1200HE-3-002 can operate up to a maximum ambient temperature of 70°C with derating. Power derating starts when ambient reaches 50°C. Up to 70°C, nominal power reduced to 600W for high line and 500W for low line.

DS1200HE-3-003 and DS1200HE-3-004 can operate up to a maximum ambient temperature of 70°C with derating. Power derating starts when ambient reaches 50°C for high line and 40°C for low line. Up to 70°C, nominal power reduced to 800W for high line. Up to 70°C, nominal power reduced to 600W for low line (shown in the power derating curves below).

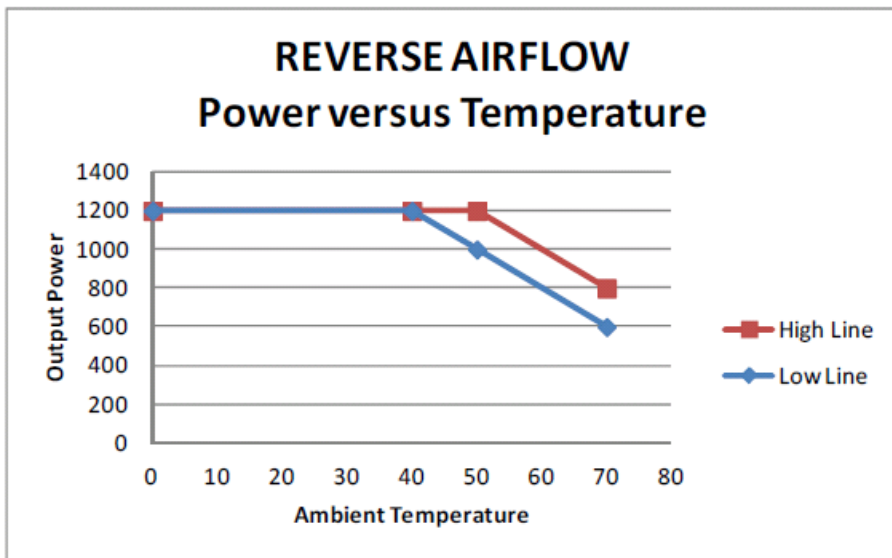
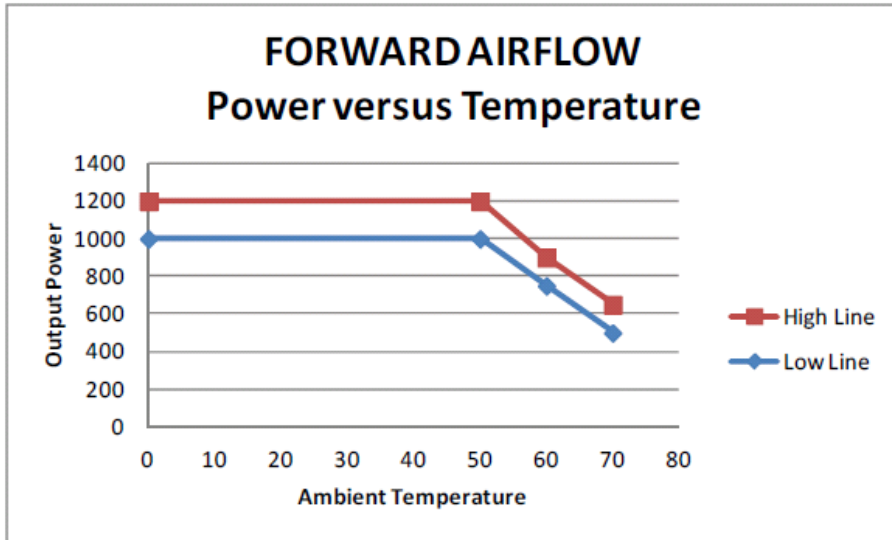

ENVIRONMENTAL SPECIFICATIONS

Storage and Shipping Temperature

The DS1200HE-3 series power supply can be stored or shipped at temperatures between -40°C to +85°C and relative humidity from 10% to 95% non-condensing.

Altitude

The DS1200HE-3 series power supply will operate within specifications at altitudes up to 10000 feet above sea level. The power supply will not be damaged when stored at altitudes up to 50000 feet above sea level.

Humidity

The DS1200HE-3 series will operate within specifications when subjected to a relative humidity from 10% to 90% non-condensing. The DS1200HE-3 series can be stored in a relative humidity from 10% to 95% non-condensing.

Vibration

The DS1200HE-3 series power supply will pass the following vibration specifications:

Non-Operating Random Vibration

Acceleration	1.87	gRMS	
Frequency Range	10 - 500	Hz	
Duration	30	Mins	
Direction	3 mutually perpendicular axis		
PSD Profile	FREQ (Hz)	SLOPE (db/oct)	PSD (g ² /Hz)
	10	/	0.009
	200	/	0.009
	500	/	0.004

Operating Random Vibration

Acceleration	0.153	gRMS	
Frequency Range	5 - 100	Hz	
Duration	30	Mins	
Direction	3 mutually perpendicular axis		
PSD Profile	FREQ (Hz)	SLOPE (db/oct)	PSD (g ² /Hz)
	5	11	0.00003
	10 - 50	/	0.0004
	100	-10	0.00003

ENVIRONMENTAL SPECIFICATIONS

Shock

The DS1200HE-3 power supply will pass the following vibration specifications:

Non-Operating Half-Sine Shock

Acceleration	30	G
Duration	18	mSec
Pulse	Half-sine	
Number of Shock	3 shocks on each of 6 faces	

Operating Half-Sine Shock

Acceleration	4	G
Duration	22	mSec
Pulse	Half-sine	
Number of Shock	3 shocks on each of 6 faces	

POWER AND CONTROL SIGNAL DESCRIPTIONS

AC Input Connector

This connector supplies the AC mains to the DS1200HE-3 series power supply.

- Pin 1 – L1
- Pin 2 – L2
- Pin 3 – Earth Ground

Output Connector – Power Blades

These pins provide the main output for the DS1200HE-3 series power supply. The main output (V_O) and the main output return pins are the positive and negative rails, respectively, of the V_O main output of the DS1200HE-3 series power supply. The main output (V_O) is electrically isolated from the power supply chassis.

- PB1 – Main Output Return
- PB2 – Main Output Return
- PB3 – Main Output Return
- PB4 – Main Output (V_O)
- PB5 – Main Output (V_O)
- PB6 – Main Output (V_O)

Output Connector – Control Signals

The DS1200HE-3 series power supply contains a 24 pins control signal header providing an analogue control interface, standby power and I²C interface signal connections.

PSON_L - (Pin A1)

This signal input pin controls the normal turning ON and Off of the main output of the DS1200HE-3 power supply. The power supply main output (V_O) will be enabled when this signal is pulled low, below 0.8 V. The power supply output (except V_{SB} output) will be disabled when this input is driven higher than 3.3V, or left open circuited.

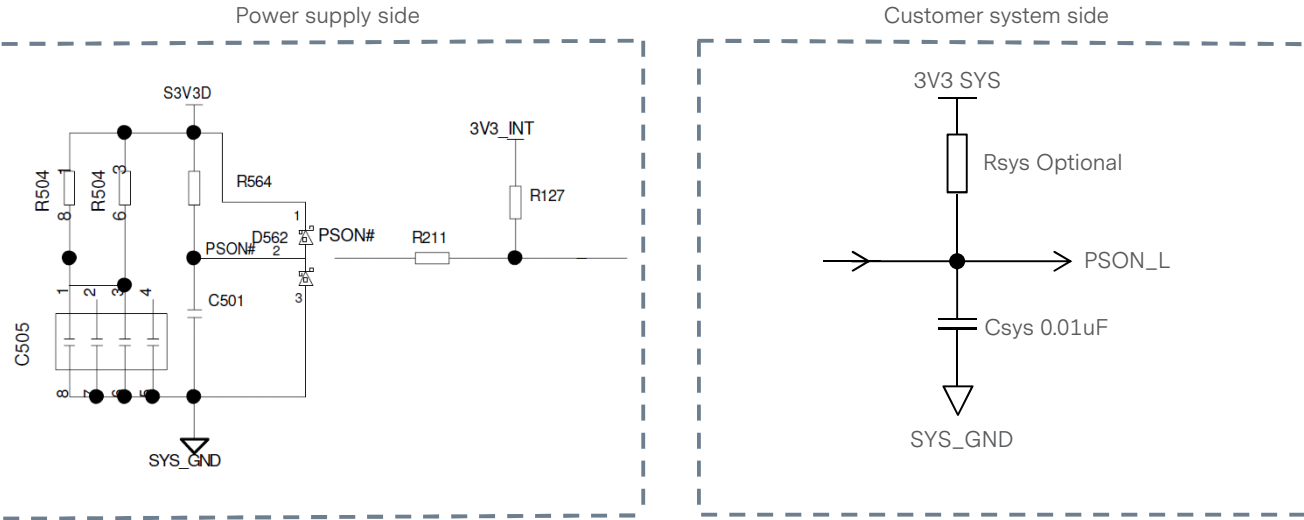

POWER AND CONTROL SIGNAL DESCRIPTIONS

VSENSE- , VSENSE+ - (Pins A2, B2)

The main output of the DS1200HE-3 is equipped with a remote sensing capability that will compensate for a power path drop around the entire loop of 400mV. This feature is implemented by connecting the VSENSE+ (pin B2) and the VSENSE- (pin A2) to the positive and negative rails of the main output, respectively, at a location that is near to the load. Care should be taken in the routing of the sense lines as any noise sources or additional filtering components introduced into the voltage rail may affect the stability of the power supply. The DS1200HE-3 will operate appropriately without the sense lines connected; however it is recommended that the sense lines be connected directly to the main output terminals if remote sensing is not required. This remote sense circuit will not raise the power supply’s output voltage to the OVP trip level. Main output remote sense has no effect on the standby output (V_{SB}).

PS_PRESENT - (Pin A4)

This signal pin is connected to main output return inside the power supply via a 220Ohm resistor. This pin is to be pull high on the system side by a resistor of 4.7K or higher. A TTL logic LOW indicates the power supply is inserted and seated into the system power supply connector. A Logic HIGH indicated the removal of the power supply.

STAND-BY, STAND-BY RETURN - (Pins A5, A6, B5, B6, C5, C6, D5, D6)

The DS1200HE-3 provides a regulated 3.3V 6A (or 5.0V 4A) auxiliary output voltage to power critical circuitry that must remain active regardless of the on/off status of the power supply’s main output. The standby output (V_{SB}) voltage is available whenever a valid AC input voltage is applied to the unit. The standby output is independently short circuit protected and is referenced to the standby output return pins (A6, B6, C6, D6).

ACOK_H - (Pin B1)

The ACOK_H signal is a normally LOW level TTL logic signal when the AC input voltage is within the allowable limits. A TTL logic HIGH level, with a 5mS early warning will be sent before the main output loses regulation. This signal is a common drain output internally pulled up in the power supply to standby output via a 1Kohm resistor. It is capable of driving the output below 0.4V with a load of 10mA.

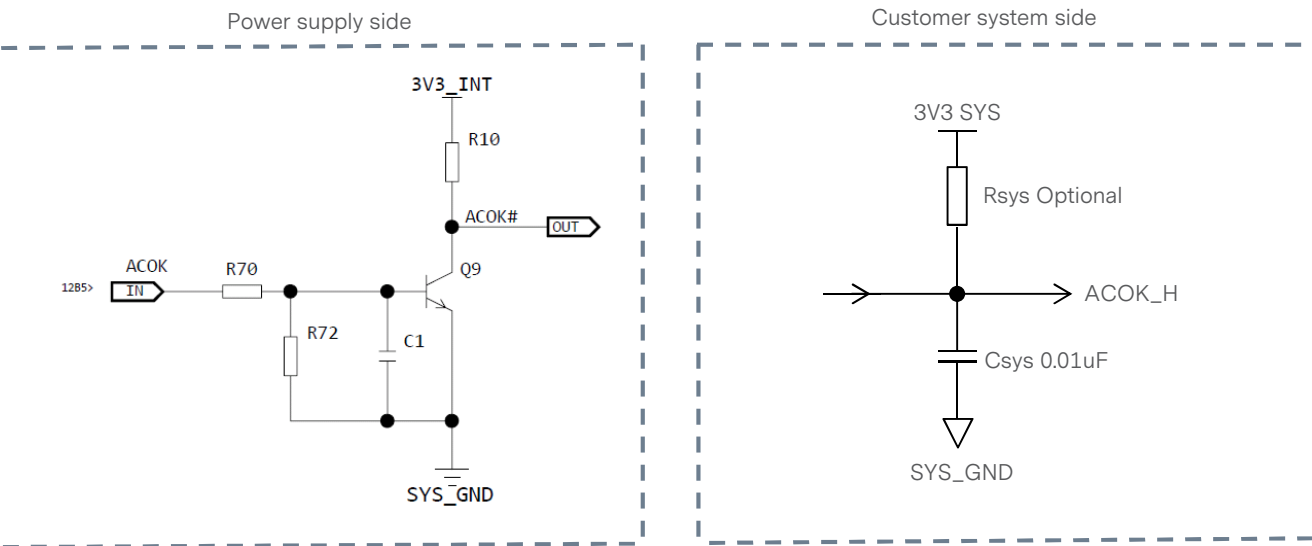

POWER AND CONTROL SIGNAL DESCRIPTIONS

ISHARE - (Pin B3)

The DS1200HE-3 supports active current sharing through a single wire connection between the power supplies. This input/output signal pin allows two or more power supplies to share the main output load current to increase the overall power capability or to operate the units in a N+1 configuration for redundancy purposes.

The voltage of this signal will be a linear slope from no load to full load. At 50A, the output of the ISHARE pin will be between 3.65 and 4.35V.

When two or more power supplies are connected and operating in parallel and each is delivering 40-50% of its rated output to the load, the power supplies will current share within 5% accuracy. When supplying light loads between 10% and 30% of its rated load, the power supplies will share within 20% accuracy. (Below 10% load, there is no guarantee of output current sharing). If any power supply is hot swapped, no glitch will occur that violates the regulation limits of the power supply defined in this specification.

PS_INHIBIT / PSKILL - (Pin B4)

This signal is used for fast output turn off on PSU, normally pulled to logic low (Isink - 3mA max) or connected to standby return on PSU mating connector. When left open power supply operation will be inhibited. This feature minimizes arcing / damage to output connector power pins during PSU removal from system chassis. This signal pin is internally pulled-up through 2K7 resistor to 3.3V internal supply.

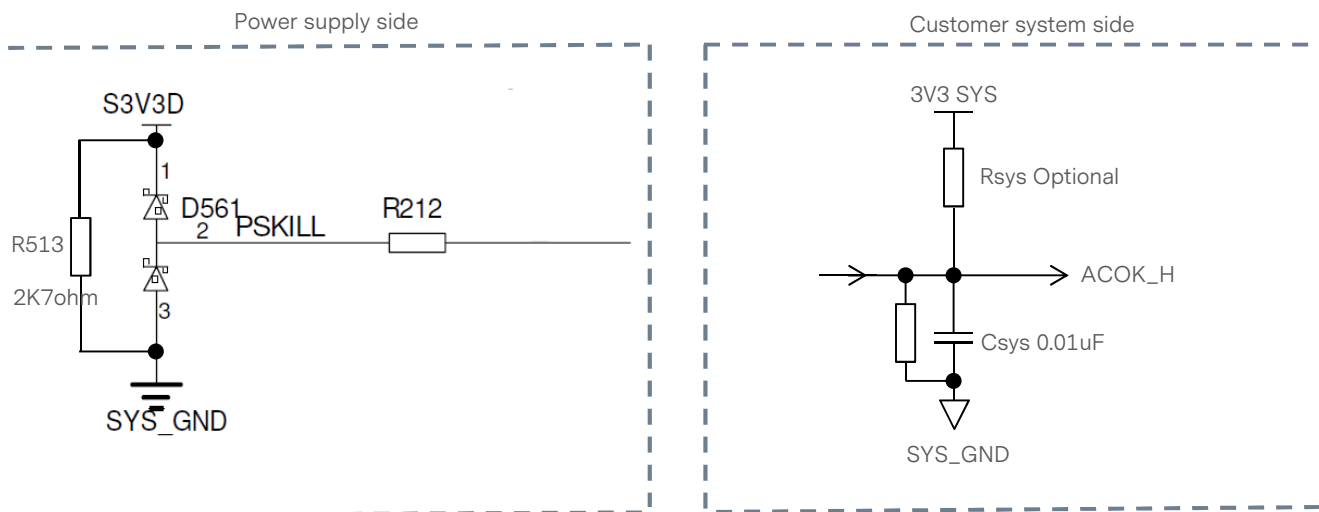

SDA, SCL and PS_INTERRUPT - (Pins C1, C2, D3)

Please refer to "Communication Bus Descriptions" section.

POWER AND CONTROL SIGNAL DESCRIPTIONS

POWER GOOD / PWOK_H - (Pin C3)

The POWER GOOD/PWOK is an output signal driven high, by the power supply to indicate that all outputs are valid. If any of the power supply outputs fails below its regulation limits, this output will be driven low. The output signal is a common drain output internally pulled up in the power supply to internal standby supply (anode side of standby output OR'ing circuit) via a 1Kohm resistor. It is capable of driving the output below 0.4V with a load of 6mA.

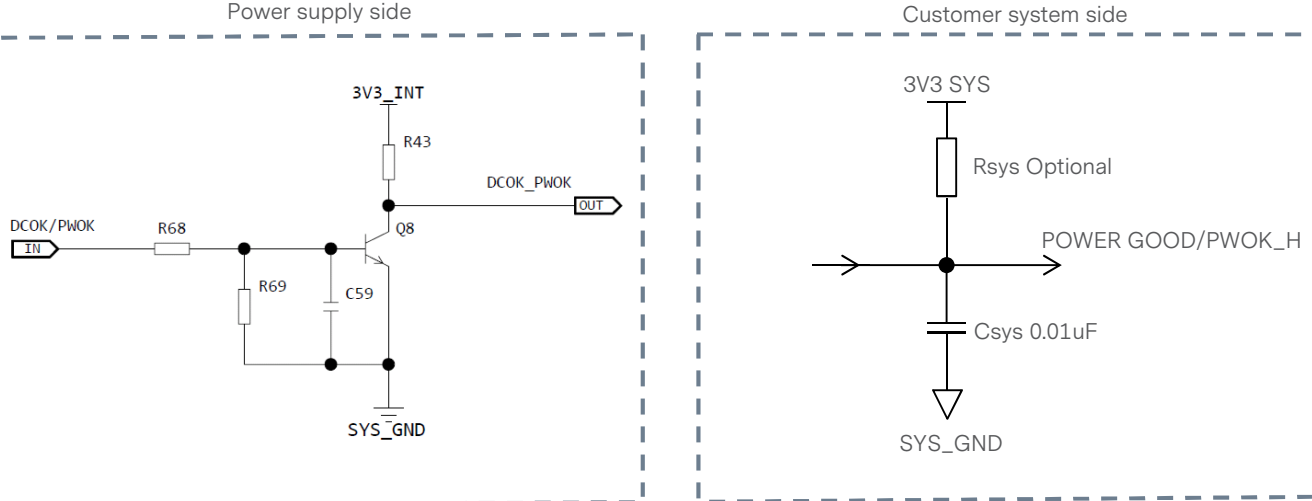

A0, A1 - (Pins D1, D2)

Please refer to "Communication Bus Descriptions" section.

VSENSE_STBY - (Pin D4)

Power supply will employ remote sense capability for the stand-by output for positive rail for a compensation of 50mV max. This pin shall be connected as close to the loading as possible, or connected to the stand-by output at the base of the output connector if not used. If left open, the remote sense does not work properly and the voltage level of the stand-by output will go lower than guaranteed spec.

COMMUNICATION BUS DESCRIPTIONS

I²C Bus Signals

The DS1200HE-3 series power supply contains enhanced monitor and control functions implemented via the I²C bus. The DS1200HE-3 series I²C functionality (PMBus™ and FRU data) can be accessed via the output connector control signals. The communication bus is powered either by the internal 3.3V supply or from an external power source connected to the standby output (i.e. accessing an unpowered power supply as long as the standby output of another power supply connected in parallel is on).

If units are connected in parallel or in redundant mode, the standby outputs must be connected together in the system. Otherwise, the I²C bus will not work properly when a unit is inserted into the system without the AC source connected.

Note: PMBus™ functionality can be accessed only when the PSU is powered up. Guaranteed communication I²C speed is 100KHz.

SDA, SCL (I²C Data and Clock Signals) - (Pins C1, C2)

I²C serial data and clock bus - these pins must be pull-up in the system by an 1Kohm resistor to the standby output.

PS_INTERRUPT - (Pin D3)

PS_INTERRUPT_L is used to send an alert signal to the system that a fault in the power supply occurred. This signal is normally logic level HIGH. It will go to a LOW logic level when a fault bit has been set in the power supply's status register. To reset the PS_INTERRUPT signal back to normal (logic HIGH level) - (1) recycle input AC power, (2) toggle PSON signal and (3) issuance of a CLEAR_FAULTS PMBus™ command.

A0, A1 (I²C Address BIT0, BIT1 Signals) - (pin D1, D2)

These two input pins are the address lines A0 and A1 to indicate the slot position the power supply occupies in the power bay and define the power supply addresses for FRU data and PMBus™ data communication. This allows the system to assign different addresses for each power supply. During I²C communication between system and power supplies, the system will be the master and power supplies will be slave.

They are internally pulled up to internal 3.3V supply with a 1K resistor.

I²C Bus Communication Interval

The interval between two consecutive I²C communications to the power supply must be at least 50ms to ensure proper monitoring functionality.

I²C Bus Signal Integrity

The noise on the I²C bus (SDA, SCL lines) due to the power supply will be less than 500mV peak-to-peak. This noise measurement should be made with an oscilloscope bandwidth limited to 100MHz. Measurements must be made at the power supply output connector with 3.2Kohm resistors pulled up to standby output and 20pF ceramic capacitors to standby output return.

The noise on the address lines A0 and A1 will be less than 100mV peak-to-peak. This noise measurement should be made at the power supply output connector.

COMMUNICATION BUS DESCRIPTIONS

I²C Bus Internal Implementation, Pull-ups and Bus Capacitances

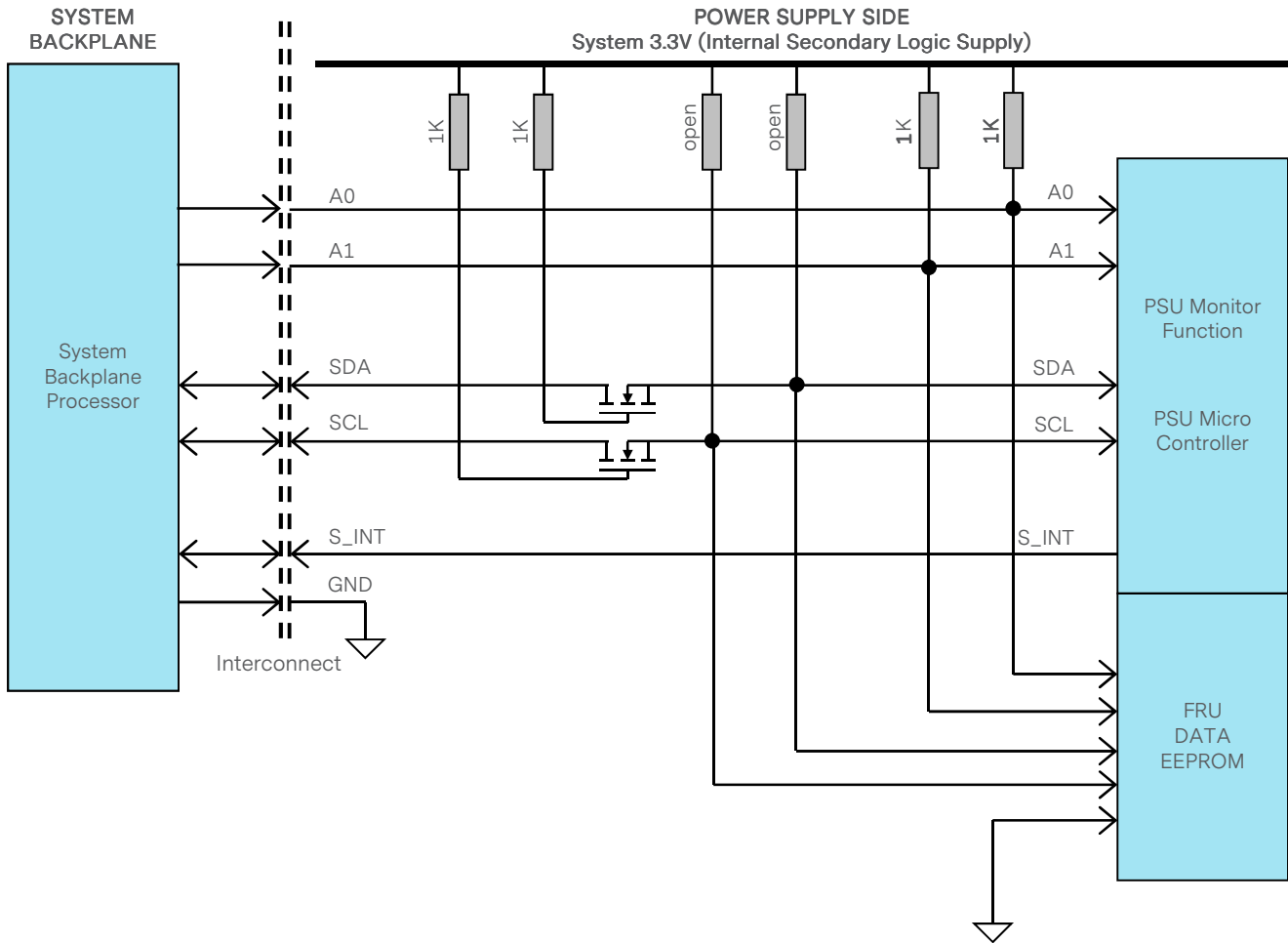

I²C Bus - Recommended external pull-ups

Electrical and interface specifications of I²C signals (referenced to standby output return pin, unless otherwise indicated):

Parameter	Condition	Symbol	Min	Type	Max	Unit
SDA, SCL Internal Pull-up Resistor		R_{int}	-	-	-	Kohm
SDA, SCL Internal Bus Capacitance		C_{int}	-	0	-	pF
Recommended External Pull-up Resistor	1 PSU	R_{ext}	-	1.0	-	Kohm
	4 PSU	R_{ext}	-	0.25	-	Kohm

COMMUNICATION BUS DESCRIPTIONS

Logic Levels

DS1200HE-3 series power supply I²C communication bus will respond to logic levels as per below:

Logic High: 5.1V nominal (Spec is 2.1V to 5.5V)**

Logic Low: 500mV nominal (Spec is 800mV max)**

**Note: Artesyn 73-769-001 I²C adapter was used.

Timings

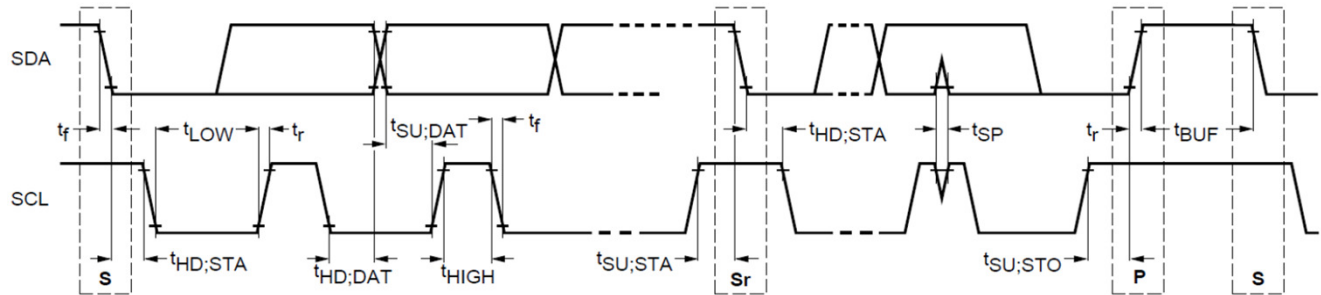

Parameter	Symbol	Standard-Mode Specs		Actual Measured		Unit
		Min	Max			
SCL clock frequency	f_{SCL}	0	100	100		KHz
Hold time (repeated) START condition	$t_{HD;STA}$	4.0	-	4.41		uS
LOW period of SCL clock	t_{LOW}	4.7	-	15.9		uS
HIGH period of SCL clock	t_{HIGH}	4.0	50	2.86		uS
Setup time for repeated START condition	$t_{SU;STA}$	4.7	-	3.565		uS
Data hold time	$t_{HD;DAT}$	0	3.45	0.2008		uS
Data setup time	$t_{SU;DAT}$	250	-	2680		nS
Rise time	t_r	-	1000	SCL = 1.078	SDA = 909	nS
Fall time	t_f	-	300	SCL = 130	SDA = 122	nS
Setup time for STOP condition	$t_{SU;STO}$	4.0	-	5.76		uS
Bus free time between a STOP and START condition	t_{BUF}	4.7	-	30.7		mSec

COMMUNICATION BUS DESCRIPTIONS

Device Addressing

The DS1200HE-3 series will respond to supported commands on the I²C™ bus that are addressed according to pins A1 and A0 pins of output connector.

Address pins are held HIGH by default via pulled up to internal 3.3V supply with a 1K resistor. To set the address as “0”, the corresponding address line should be pulled down to logic ground level. Below tables show the address of the power supply with A0 and A1 pins set to either “0” or “1”.

PSU Slot	Slot ID Bits		PMBus™ Address	EEPROM (FRU) Address
	A1	A0		
1	0	0	0xB0h	0xA0h
2	0	1	0xB2h	0xA2h
3	1	0	0xB4h	0xA4h
4	1	1	0xB6h	0xA6h

Note - Default PMBus™ address when A0 and A1 are left open.

COMMUNICATION BUS DESCRIPTIONS

I²C Clock Synchronization

The DS1200HE-3 series power supply applies clock stretching. An addressed slave power supply holds the clock line (SCL) low after receiving (or sending) a byte, indicating that it is not yet ready to process more data. The system master that is communicating with the power supply will attempt to raise the clock to transfer the next bit but must verify that the clock line was actually raised. If the power supply is clock stretching, the clock line will still be low (because the connections are open-drain).

The maximum time-out condition for clock stretching for DS1200HE-3 series is 100 milliseconds. The maximum low timeout condition for clock stretching is 25 milliseconds.

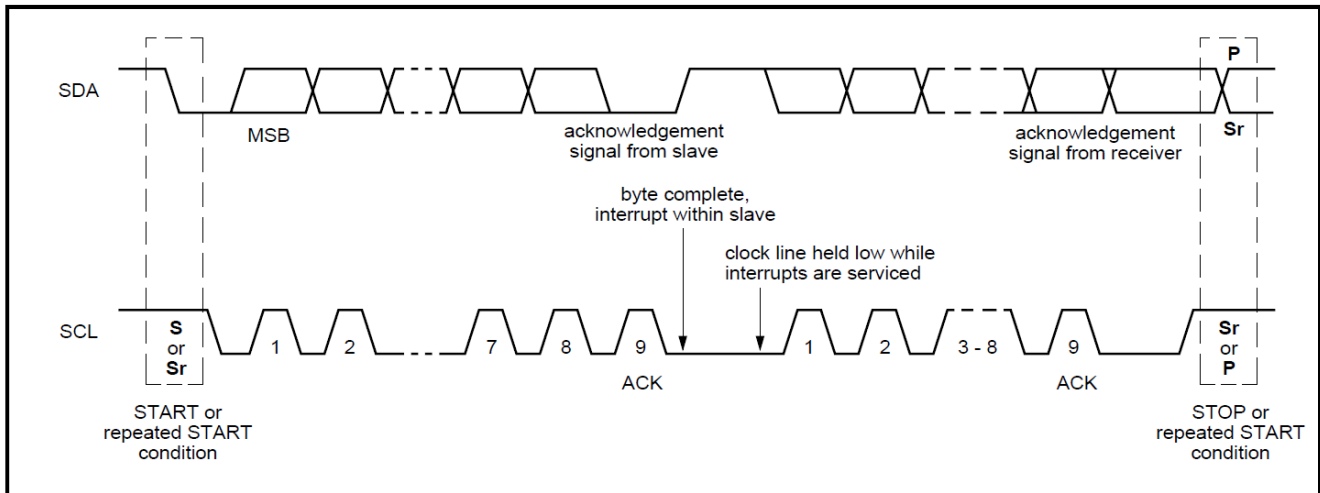

COMMUNICATION BUS DESCRIPTIONS

Power Supply Status Register, PMBus™ Register 0x79h

Power supply status monitoring can be done via the PMBus™ register 0x79h or as I/O expander. Detailed explanation of functions is given below:

Upper Byte							
BIT 7	BIT 6	BIT 5	BIT 4	BIT 3	BIT 2	BIT 1	BIT 0
Vout	Iout/Pout	Input	MFR	Power Good	Fan	Other	Unknown

Lower Byte							
BIT 7	BIT 6	BIT 5	BIT 4	BIT 3	BIT 2	BIT 1	BIT 0
Busy	OFF	Vout_OV	Iout_OC	Vin_UV	Temperature	CML	None of the above

Upper Byte

- Vout - Output Voltage Status
- This bit will be set high when fault has been triggered on main output.
- Iout/Pout - Output Current / Output Power Status
- This bit will be set high when fault has been triggered on Iout/Pout.
- Input - Input Voltage Status
- This bit will be set high when fault has been triggered on input voltage.
- MFR - Manufacturer Status
- This bit will be set high when fault has been triggered on manufacturer defined fault.
- Power_Good - Power Good Status
- This bit will be set high when fault has been triggered on manufacturer defined fault.
- Fan - Fan status
- This bit will be set high when fault has been triggered on fan control.
- Other - Not used
- Unknown - Not used

Lower Byte

- Busy - This bit will be set high when the receiving device is too busy to respond on the communication on the bus.
- Off - Not used
- Vout_OV - Over Voltage Protection
- This bit will be set high when fault has been triggered on main output.
- Iout_OC - Over Current Protection
- This bit will be set high when fault has been triggered on output load.
- Vin_UV - Under Voltage Protection
- This bit will be set high when input under-voltage occur.
- Temperature - Over Temperature Protection
- This bit will be set high when OTP is triggered.
- CML - Communication, Memory or Logic Fault
- This bit will be set high when memory or logic fault has occurred.
- None of the above - This bit will be set high when a fault triggered is not listed above.

COMMUNICATION BUS DESCRIPTIONS

Note: Register 0x79h gives the general status of the PSU but for specific area of interest, assigned registers should read. Details are given below status register code.

Status Register Code		
Signal Name	Code (Binary)	Code (Hex)
Status_Vout	01111010	7A
Status_lout	01111011	7B
Status_Input	01111100	7C
Status_Temperature	01111101	7D
Status_CML	01111110	7E
Status_Other	01111111	7F
Status_MFR_Specific	10000000	80
Status_Fans_1_2	10000001	81
Status_Fans_3_4	10000010	82

COMMUNICATION BUS DESCRIPTIONS

FRU (EEPROM) Data

The FRU (Field Replaceable Unit) data format is compliant with the Intel IPMI v1.0 specification. The DS1200HE-3 uses 1 page of EEPROM for FRU purpose. The one page of EEPROM contains up to 256 byte-sized data locations.

Where:	OFFSET	-The OFFSET denotes the address in decimal format of a particular data byte within DS1200HE-3 EEPROM.
	VALUE	-The VALUE details data written to a particular memory location of the EEPROM.
	DEFINITION	-The contents DEFINITION refers to the definition of a particular data byte.

DS1200HE-3 series FRU (EEPROM) Data:

OFFSET		DEFINITION	SPEC VALUE	
(DEC)	(HEX)	(REMARKS)	(DEC)	(HEX)
0	00	FORMAT VERSION NUMBER (Common header)	1	01
1	01	INTERNAL USE AREA STARTING OFFSET	10	0A
2	02	CHASSIS INFO AREA STARTING OFFSET	0	00
3	03	BOARD INFO AREA STARTING OFFSET	1	01
4	04	PRODUCT INFO AREA STARTING OFFSET	0	00
5	05	MULTI RECORD AREA STARTING OFFSET	13	0D
6	06	Reserved	0	00
7	07	Common Header Checksum	231	E7
8	08	Format Version Number (Board Info)	1	01
9	09	Board Info Area Length	72	48
10	0A	Language Code	0	00
11	0B	Manufacturing Date/Time	0	00
12	0C		0	00
13	0D		0	00
14	0E	Board Manufacturer Type/Length	3	03
15	0F	Board Manufacturer	48	30
16	10		211	D3
17	11		164	A4
18	12	Board Product Name Type/Length	31	1E
19	13	Board Product Name, 30 byte sequence "PWR SPLY, 1200W, DS1200HE-3" In Decimal = 080, 087, 082, 032, 083, 080, 076, 089, 044, 049, 050, 048, 048, 087, 044, 068, 083, 049, 050, 048, 048, 072, 069, 045, 051, 032, 032, 032, 032, 032 In Hex = 50H, 57H, 52H, 20H, 53H, 50H, 4CH, 59H, 2CH, 31H, 32H, 30H, 30H, 57H, 2CH, 44H, 53H, 31H, 32H, 30H, 30H, 48H, 45H, 2DH, 33H, 20H, 20H, 20H, 20H, 20H	80	50
20	14		87	57
21	15		82	52
22	16		32	20
23	17		83	53
24	18		80	50
25	19		76	4C
26	1A		89	59
27	1B		44	2C
28	1C		49	31
29	1D		50	32
30	1E		48	30
31	1F		48	30
32	20		87	57
33	21		44	2C
34	22		68	44
35	23		83	53
36	24		49	31
37	25		50	32

COMMUNICATION BUS DESCRIPTIONS

DS1200HE-3 series FRU (EEPROM) Data:

OFFSET		DEFINITION (REMARKS)	SPEC VALUE	
(DEC)	(HEX)		(DEC)	(HEX)
38	26		48	30
39	27		48	30
40	28		72	48
41	29		69	45
42	2A		45	2D
43	2B		51	33
44	2C		32	20
45	2D		32	20
46	2E		32	20
47	2F		32	20
48	30		32	20
49	31	Board Serial Number Type/Length	14	0E
50	32	Board Serial Number	67	43
51	33		67	43
52	34		77	4D
53	35		77	4D
54	36		77	4D
55	37		77	4D
56	38		77	4D
57	39		84	54
58	3A		84	54
59	3B		84	54
60	3C		88	58
61	3D		88	58
62	3E		88	58
63	3F		88	58
64	40	Board Part Number Type/Length	9	09
65	41	Board Part Number	80	50
66	42		80	50
67	43		80	50
68	44		80	50
69	45		80	50
70	46		80	50
71	47		82	52
72	48		82	52
73	49		82	52
74	4A	FRU File ID Type/Length	1	01
75	4B	FRU File ID Data 01h for DS1200HE-3 platform 02h for DS1200HE-3-002 platform 03h for DS1200HE-3-003 platform 04h for DS1200HE-3-004 platform	1	01
76	4C	Type/Length	3	03
77	4D	Reserved	0	00
78	4E		0	00
79	4F	Board Area Checksum	240	E0
80	50	Internal Use Area Format Version	1	01
81	51	CDE Format Presence	67	43
82	52		68	44
83	53		69	45
84	54		32	20
85	55	Board Info Area Part Number Checksum	0	00
86	56	Chassis Info Area Part Number Checksum	0	00
87	57	Product Info Area Part Number Checksum	0	00

COMMUNICATION BUS DESCRIPTIONS

DS1200HE-3 series FRU (EEPROM) Data:

OFFSET		DEFINITION (REMARKS)	SPEC VALUE	
(DEC)	(HEX)		(DEC)	(HEX)
88	58	Header Revision and Flags	1	01
89	59	Feature Flags	1	01
90	5A	Units	0	00
91	5B	EEPROM Size	0	00
92	5C		1	01
93	5D	Header Length	15	0F
94	5E	Header Checksum	213	D5
95	5F	Element Count	2	02
96	60	Element Type #1	4	04
97	61	Element Offset #1	133	85
98	62		0	00
99	63	Element Type #2	7	07
100	64	Element Offset #2	154	9A
101	65		0	00
102	66	Reserved	0	00
103	67		0	00
104	68	Record Type ID	0	00
105	69	Record Info	130	82
106	6A	Record Data Length	24	18
107	6B	Record Data Checksum	254	FE
108	6C	Record Header Checksum	80	50
109	6D	Overall Capacity	176	B0
110	6E		4	04
111	6F	Peak VA	160	A0
112	70		5	05
113	71	Inrush Current	40	28
114	72	Inrush Interval in ms	10	0A
115	73	Low End Input Voltage Range 1	40	28
116	74		35	23
117	75	High End Input Voltage Range 1	32	20
118	76		103	67
119	77	Low End Input Voltage Range 2	0	00
120	78		0	00
121	79	High End Input Voltage Range 2	0	00
122	7A		0	00
123	7B	Low End Input Frequency Range	47	2F
124	7C	High End Input Frequency Range	63	3F
125	7D	A/C Dropout Tolerance	10	0A

COMMUNICATION BUS DESCRIPTIONS

DS1200HE-3 series FRU (EEPROM) Data:

OFFSET		DEFINITION (REMARKS)	SPEC VALUE	
(DEC)	(HEX)		(DEC)	(HEX)
126	7E	Binary Flags Feature Flags. Bit(s) meaning 7:6 reserved, write as 00b 5 PMBUS capable or not. 1 if supported 0 if not. 4 Tachometer Pulses per Rotation/Predictive Fail Polarity. See Error! Reference source not found. For more information. 3 Hot Swap Support. Identifies whether (1b) or not (0b) the power. 2 Auto-switch. Identifies whether (1b) or not (0b) the power supply supports auto-switch, and provides additional meaning to the input voltage range fields of this record. 1 Power Factor Correction. Identifies whether (1b) or not (0b) the power supply supports PFC. 0 Predictive Fail Support. Identifies whether (1b) or not (0b) the power supply supports the predictive fail pin. See also section.	47	2F
127	7F	Peak Wattage	255	FF
128	80		255	FF
129	81	Combined Wattage	0	00
130	82		0	00
131	83		0	00
132	84	Predictive Fail Tachometer Lower Threshold	0	00
133	85	Element Type #1	4	04
134	86	Element Length #1	28	1C
135	87		0	00
136	88	Element Checksum #1	216	D8
137	89	Service Tag Length	7	07
138	8A	Service Tag	0	00
139	8B		0	00
140	8C		0	00
141	8D		0	00
142	8E		0	00
143	8F		0	00
144	90		0	00
145	91	Related Service Tag Count	1	01
146	92	Related Service Tags	0	00
147	93		0	00
148	94		0	00
149	95		0	00
150	96		0	00
151	97		0	00
151	98		0	00
153	99	Element Type #2	0	00
154	9A	Element Length #2	20	14
155	9B		0	00
156	9C	Element Checksum #2	216	D8
157	9D	Asset Tag Length	15	0A

COMMUNICATION BUS DESCRIPTIONS

DS1200HE-3 series FRU (EEPROM) Data:

OFFSET		DEFINITION	SPEC VALUE	
(DEC)	(HEX)	(REMARKS)	(DEC)	(HEX)
158	9E	Asset Tag	15	0A
159	9F		0	00
160	A0		0	00
161	A1		0	00
162	A2		0	00
163	A3		0	00
164	A4		0	00
165	A5		0	00
166	A6		0	00
167	A7		0	00
168	A8	Unused Area	0	00
169	A9		0	00
170	AA		0	00
171	AB		0	00
172	AC		0	00
173	AD		0	00
174	AE		0	00
175	AF		0	00
176	B0		0	00
177	B1		0	00
178	B2		0	00
179	B3		0	00
180	B4		0	00
181	B5		0	00
182	B6		0	00
183	B7		0	00
184	B8		0	00
185	B9		0	00
186	BA		0	00
187	BB		0	00
188	BC		0	00
189	BD		0	00
190	BE		0	00
191	BF		0	00
192	C0		0	00
193	C1		0	00
194	C2		0	00
195	C3		0	00
196	C4		0	00
197	C5		0	00
198	C6		0	00
199	C7		0	00
200	C8		0	00
201	C9		0	00
202	CA		0	00
203	CB		0	00
204	CC		0	00
205	CD		0	00
206	CE		0	00
207	CF		0	00
208	D0	0	00	
209	D1	0	00	
210	D2	0	00	
211	D3	0	00	
212	D4	0	00	
213	D5	0	00	
214	D6	0	00	
215	D7	0	00	
216	D8	0	00	

COMMUNICATION BUS DESCRIPTIONS

DS1200HE-3 series FRU (EEPROM) Data:

OFFSET		DEFINITION (REMARKS)	SPEC VALUE	
(DEC)	(HEX)		(DEC)	(HEX)
216	D8	Unused Area	0	00
217	D9		0	00
218	DA		0	00
219	DB		0	00
220	DC		0	00
221	DD		0	00
222	DE		0	00
223	DF		0	00
224	E0		0	00
225	E1		0	00
226	E2		0	00
227	E3		0	00
228	E4		0	00
229	E5		0	00
230	E6		0	00
231	E7		0	00
232	E8		0	00
233	E9		0	00
234	EA		0	00
235	EB		0	00
236	EC		0	00
237	ED		0	00
238	EE		0	00
239	EF		0	00
240	F0		0	00
241	F1		0	00
242	F2		0	00
243	F3		0	00
244	F4		0	00
245	F5		0	00
246	F6		0	00
247	F7		0	00
248	F8		0	00
249	F9		0	00
250	FA		0	00
251	FB		0	00
252	FC		0	00
253	FD		0	00
254	FE		0	00
255	FF		0	00

COMMUNICATION BUS DESCRIPTIONS

DS1200HE-3-002 series FRU (EEPROM) Data:

OFFSET		DEFINITION	SPEC VALUE	
(DEC)	(HEX)	(REMARKS)	(DEC)	(HEX)
INTERNAL USE AREA, 40 BYTES				
19	13	Board Product Name, 30 byte sequence "PWR SPLY, 1200W, DS1200HE-3-002" In Decimal = 080, 087, 082, 032, 083, 080, 076, 089, 044, 049, 050, 048, 048, 087, 044, 068, 083, 049, 050, 048, 048, 072, 069, 045, 051, 045, 048, 048, 050, 032 In Hex = 50H, 57H, 52H, 20H, 53H, 50H, 4CH, 59H, 2CH, 31H, 32H, 30H, 30H, 57H, 2CH, 44H, 53H, 31H, 32H, 30H, 30H, 48H, 45H, 2DH, 33H, 2DH, 30H, 30H, 32H, 20H	80	50
20	14		87	57
21	15		82	52
22	16		32	20
23	17		83	53
24	18		80	50
25	19		76	4C
26	1A		89	59
27	1B		44	2C
28	1C		49	31
29	1D		50	32
30	1E		48	30
31	1F		48	30
32	20		87	57
33	21		44	2C
34	22		66	44
35	23		83	53
36	24		49	31
37	25		50	32
38	26		48	30
39	27	48	30	
40	28	72	48	
41	29	69	45	
42	2A	45	2D	
43	2B	51	33	
44	2C	45	2D	
45	2D	48	30	
46	2E	48	30	
47	2F	50	32	
48	30	32	20	
75	4B	FRU File ID Data 01h for DS1200HE-3 platform 02h for DS1200HE-3-002 platform 03h for DS1200HE-3-003 platform 04h for DS1200HE-3-004 platform	2	02
79	4F	Board Area Checksum	160	A0

COMMUNICATION BUS DESCRIPTIONS

DS1200HE-3-003 series FRU (EEPROM) Data:

OFFSET		DEFINITION	SPEC VALUE	
(DEC)	(HEX)	(REMARKS)	(DEC)	(HEX)
INTERNAL USE AREA, 40 BYTES				
19	13	Board Product Name , 30 byte sequence "PWR SPLY, 1200W, DS1200HE-3-003" In Decimal = 080, 087, 082, 032, 083, 080, 076, 089, 044, 049, 050, 048, 048, 087, 044, 068, 083, 049, 050, 048, 048, 072, 069, 045, 051, 045, 048, 048, 051, 032 In Hex = 50H, 57H, 52H, 20H, 53H, 50H, 4CH, 59H, 2CH, 31H, 32H, 30H, 30H, 57H, 2CH, 44H, 53H, 31H, 32H, 30H, 30H, 48H, 45H, 2DH, 33H, 2DH, 30H, 30H, 33H, 20H	80	50
20	14		87	57
21	15		82	52
22	16		32	20
23	17		83	53
24	18		80	50
25	19		76	4C
26	1A		89	59
27	1B		44	2C
28	1C		49	31
29	1D		50	32
30	1E		48	30
31	1F		48	30
32	20		87	57
33	21		44	2C
34	22		66	44
35	23		83	53
36	24		49	31
37	25		50	32
38	26		48	30
39	27	48	30	
40	28	72	48	
41	29	69	45	
42	2A	45	2D	
43	2B	51	33	
44	2C	45	2D	
45	2D	48	30	
46	2E	48	30	
47	2F	51	33	
48	30	32	20	
75	4B	FRU File ID Data 01h for DS1200HE-3 platform 02h for DS1200HE-3-002 platform 03h for DS1200HE-3-003 platform 04h for DS1200HE-3-004 platform	3	03
79	4F	Board Area Checksum	158	9E

COMMUNICATION BUS DESCRIPTIONS

DS1200HE-3-004 series FRU (EEPROM) Data:

OFFSET		DEFINITION	SPEC VALUE	
(DEC)	(HEX)	(REMARKS)	(DEC)	(HEX)
INTERNAL USE AREA, 40 BYTES				
19	13	Board Product Name, 30 byte sequence "PWR SPLY, 1200W, DS1200HE-3-004" In Decimal = 080, 087, 082, 032, 083, 080, 076, 089, 044, 049, 050, 048, 048, 087, 044, 068, 083, 049, 050, 048, 048, 072, 069, 045, 051, 045, 048, 048, 052, 032 In Hex = 50H, 57H, 52H, 20H, 53H, 50H, 4CH, 59H, 2CH, 31H, 32H, 30H, 30H, 57H, 2CH, 44H, 53H, 31H, 32H, 30H, 30H, 48H, 45H, 2DH, 33H, 2DH, 30H, 30H, 34H, 20H	80	50
20	14		87	57
21	15		82	52
22	16		32	20
23	17		83	53
24	18		80	50
25	19		76	4C
26	1A		89	59
27	1B		44	2C
28	1C		49	31
29	1D		50	32
30	1E		48	30
31	1F		48	30
32	20		87	57
33	21		44	2C
34	22		66	44
35	23		83	53
36	24		49	31
37	25		50	32
38	26		48	30
39	27	48	30	
40	28	72	48	
41	29	69	45	
42	2A	45	2D	
43	2B	51	33	
44	2C	45	2D	
45	2D	48	30	
46	2E	48	30	
47	2F	52	34	
48	30	32	20	
75	4B	FRU File ID Data 01h for DS1200HE-3 platform 02h for DS1200HE-3-002 platform 03h for DS1200HE-3-003 platform 04h for DS1200HE-3-004 platform	4	04
79	4F	Board Area Checksum	156	9C

PMBus™ SPECIFICATIONS

The DS1200HE-3 series is compliant with the industry standard PMBus™ protocol for monitoring and control of the power supply via the I²C interface port.

DS1200HE-3 Series PMBus™ General Instructions

Equipment Setup

The following is typical I²C communication setup:

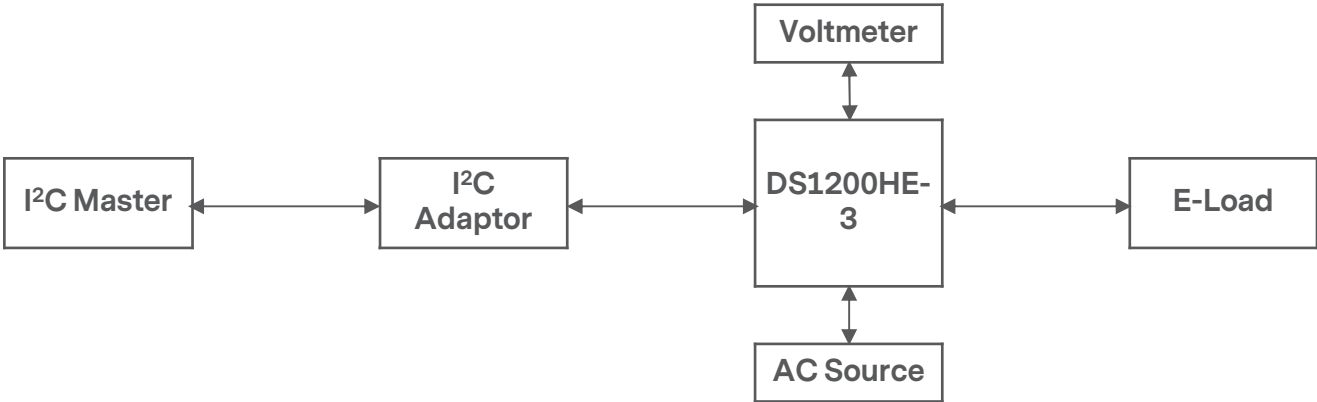

PMBus™ Writing Instructions

When writing to any PMBus™ R/W registers, always do the following:

Disable write protect (command 10h) by writing any of the following accordingly:

- Levels: 00h - Enable writing to all writeable commands
- 20h - Disables write except 10h, 01h, 00h, 02h and 21h commands
- 40h - Disables write except 10h, 01h, and 00h commands
- 80h - Disable write except 0x00h

To save changes on the USER PMBus™ Table:

Use send byte command: 15h STORE_USER_ALL

To save changes on the DEFAULT PMBus™ Table:

Use send byte command: 11h STORE_DEFAULT_ALL

Wait for 5 seconds, turn off the PSU, wait for another 5 seconds before turning it on.

PMBus™ SPECIFICATIONS

The DS1200HE-3 Series Supported PMBus™ Command List:

Command Code	Command Name	Default Value	Access Type	Data Bytes	Data Format	Description
01h	OPERATION	80	R/W	1		Used to turn the unit ON/OFF in conjunction with the input CONTROL pin. It is also used to set output to upper or lower margin voltages.
	b7:6	10				00 - Immediate turn OFF (No sequencing) 01 - Soft turn OFF (With sequencing) 10 - PSU ON
	b5:2	0000				
	b1:0	00				Reserved
02h	ON_OFF_CONFIG	1C	R/W	1		Configures the combination of CONTROL pin and serial communication commands needed to turn the unit ON/OFF.
	b7:5	000				Reserved
	b4 - Enable CONTROL pin and serial communication control.	1				0 - Unit powers up any time power is present regardless of the state of CONTROL pin. 1 - Unit powers up as dictated by CONTROL pin and OPERATION command (b3:0).
	b3 - Serial communication control	1				0 - Unit ignores ON/OFF portion of the OPERATION command. 1 - Enables serial communication ON/OFF portion of OPERATION command. Requires CONTROL pin to be asserted for the unit to start and energize the output.
	b2 - Sets how the unit responds to CONTROL pin	1				0 - Unit ignores CONTROL pin. (ON/OFF controlled by OPERATION command). 1 - Unit requires CONTROL pin to be asserted to start the unit.
	b1 - CONTROL pin polarity	0				0 - Active low (Pull low to start the unit) 1 - Active high (Pull high to start the unit)
	b0 - CONTROL pin action	0				0 - Use programmed turn ON/OFF delay. 1 - Turn OFF the output and stop transferring energy to the output as fast as possible.
03h	CLEAR_FAULTS	FF	S			
10h	WRITE_PROTECT	00	R/W	1		Used to control writing to the PMBus™ device. 80h - Disables write except 10h 40h - Disables write except 10h, 01h, 00h 20h - Disables write except 10h, 01h, 00h, 02h and 21h commands. 00 - Enables write to all writeable commands.

PMBus™ SPECIFICATIONS

The DS1200HE-3 Series Supported PMBus™ Command List:

Command Code	Command Name	Default Value	Access Type	Data Bytes	Data Format	Description
11h	STORE_DEFAULT_ALL	-	S	0		Copies the value of the operating memory table to the matching DEFAULT non-volatile memory.
12h	RESTORE_DEFAULT_ALL	-	S	0		Copies the entire contents of the DEFAULT non-volatile memory to the operating memory table.
15h	STORE_USER_ALL	-	S	0		Copies the operating memory table to the matching USER non-volatile memory.
16h	RESTORE_USER_ALL	-	S	0		Copies the entire USER non-volatile memory to the operating memory table.
19h	CAPABILITY	90	R	1		Provides a way for the hosts system to determine some key capabilities of a PMBus™ device.
	b7 - Packet Error Checking	1				0 - PEC not supported 1 - PEC supported
	b6 - Maximum Bus Speed	0				0 - Maximum supported bus speed, 100KHz 1 - Maximum supported bus speed, 400KHz
	b5 - SMBALERT	0				0 - SMBus Alert Pin not supported. 1 - SMBus Alert Pin supported.
	b4:0	00000				Reserved
20h	VOUT_MODE	17	R	1		Specifies the mode and parameters of output voltage related data formats.
21h	VOUT_COMMAND	1819	R/W	2	Linear	Sets the output voltage reference. Vout command sends discreet value to change or trim output voltage. The value acts as digital reference of the power supply after additional operations are performed (to make the representation compatible). Affects OVP_WARNING and FAULT LIMIT, as well as POWER_GOOD_ON/OFF level.
22h	VOUT_TRIM		R/W	2		Not supported
23h	VOUT_CAL_OFFSET		R/W	2		Not supported
24h	VOUT_MAX	1933	R	2	Linear	Read Only (12.6V)
30h	COEFFICIENTS	NA	BR	6	Hex	Use to retrieve the m, b and R coefficients, needed for DIRECT data format.
	byte 5					R byte
	byte 4:3					b low byte, b high byte
	byte 2:1					m low byte, m high byte
31h	POUT_MAX	NA	R	2	Linear	Sets the operating power limit condition. 1550W
35h	VIN_ON	NA	R	2	Linear	Sets the value of input, in volts, at which the unit should start. ACGOOD 88Vac

PMBus™ SPECIFICATIONS

The DS1200HE-3 Series Supported PMBus™ Command List:

Command Code	Command Name	Default Value	Access Type	Data Bytes	Data Format	Description
36h	VIN_OFF	NA	R	2	Linear	Sets the value of input, in volts, at which the unit should stop power conversion. ACBAD 79Vac
38h	IOUT_CAL_GAIN	NA	R	2		The ratio of voltage across the current sense to actual current.
39h	IOUT_CAL_OFFSET	NA	R	2		Used to null any offsets in the current sensing circuit. Normally used in conjunction with the IOUT_SCALE to minimize current sensing error.
3Ah	FAN_CONFIG_1_2	90	R	1		Read only to reflect setting of fans.
	b7	1				1 - Fan is installed in position 1. 0 - No fan is installed in position 1.
	b6	0				1 - Fan is commanded in RPM. 0 - Fan is commanded in DC.
	b5:4	01				00 - 1 pulse per revolution 01 - 2 pulses per revolution 10 - 3 pulses per revolution 11 - 4 pulses per revolution
	b3	0				1 - Fan is installed in position 2. 0 - No fan is installed in position 2.
	b2	0				1 - Fan is commanded in RPM. 0 - Fan is commanded in DC.
	b1:0	00				00 - 1 pulse per revolution 01 - 2 pulses per revolution 10 - 3 pulses per revolution 11 - 4 pulses per revolution
3Bh	FAN_COMMAND_1 *(used by both fan 1 and 2)	0000	R/W	2	Linear	Adjusts the operation of the fans. The device may override the command, if it requires higher value, to maintain proper device temperature. RPM control - Commands speeds from 0-65535 RPM. Duty cycle control - Commands speeds from 0 to 100%.
40h	VOUT_OV_FAULT_LIMIT	1A66	R/W	2	Linear	Sets output over voltage threshold. (13.2V)
41h	VOUT_OV_FAULT_RESPONSE	80	R	1		Unit latches OFF. Resets on PSON or CONTROL pin recycle or AC recycle.
42h	VOUT_OV_WARN_LIMIT	1999	R/W	2	Linear	Sets over-voltage warning threshold. (12.8V)
43h	VOUT_UV_WARN_LIMIT	1666	R/W	2	Linear	Sets under-voltage warning threshold. (11.2V)
44h	VOUT_UV_FAULT_LIMIT	1599	R/W	2	Linear	Sets under-voltage fault threshold. (10.8V)
45h	VOUT_UV_FAULT_RESPONSE	80	R	1		Turn PSU OFF

PMBus™ SPECIFICATIONS

The DS1200HE-3 Series Supported PMBus™ Command List:

Command Code	Command Name	Default Value	Access Type	Data Bytes	Data Format	Description
46h	IOUT_OC_FAULT_LIMIT	EB60	R	2	Linear	Sets the over current threshold in Amps. (108A for hi line and low line)
47h	IOUT_OC_FAULT_RESPONSE	C0	R	1		OCP ride through. If OCP persists.
4Ah	IOUT_OC_WARN_LIMIT	EB20	R	2	Linear	Sets the over current warning threshold in Amps. (100A for hi line and low line)
4Fh	OT_FAULT_LIMIT	EB48	R/W	2	Linear	Secondary ambient temperature fault threshold, in degree C. (105degC)
50h	OT_FAULT_RESPONSE	F8	R	1		Turn PSU OFF and will retry indefinitely. Supported enable/disable of protection and recoverability.
51h	OT_WARN_LIMIT	EB20	R	2	Linear	Secondary ambient temperature warning threshold, in degree C. Operating limit (100degC)
5Eh	POWER_GOOD_ON	1766	R	2	Linear	Sets the threshold by which the power good signal is asserted. (11.7V)
5Fh	POWER_GOOD_OFF	16CC	R	2	Linear	Sets the threshold by which the power good signal is de-asserted. (11.4V)
60h	TON_DELAY	TBD	R	2	Linear	Sets the time (sec), from start condition (Power ON) until the output starts to rise. (2sec)
61h	TON_RISE	8BD7	R	2	Linear	Sets the time (ms), for the output rises from 0 to regulation. (30ms)
64h	TOFF_DELAY	C280	R	2	Linear	Sets the time (ms), from a stop condition (Power OFF) until the output starts to drop (converter OFF). (2.5sec)
78h	STATUS_BYTE	-	R	1		Returns the summary of critical faults.
	b7 - BUSY	-				Not supported.
	b6 - OFF	-				Unit is OFF.
	b5 - VOUT_OV	-				Output over-voltage fault has occurred.
	b4 - IOUT_OC	-				Output over-current fault has occurred.
	b3 - VIN_UV	-				An input under-voltage fault has occurred.
	b2 - TEMPERATURE	-				A temperature fault or warning has occurred.
	b1 - CML	-				A communication, memory or logic fault has occurred.
	b0 - NONE OF THE ABOVE	-				A fault warning not listed in bits[7:1] has occurred.

PMBus™ SPECIFICATIONS

The DS1200HE-3 Series Supported PMBus™ Command List:

Command Code	Command Name	Default Value	Access Type	Data Bytes	Data Format	Description
79h	STATUS_WORD	-	R	2		Summary of units fault and warning status.
	b15 - VOUT					An output voltage fault or warning has occurred.
	b14 - IOUT/POUT					An output current or power fault or warning has occurred.
	b13 - INPUT					An input voltage, current or power fault or warning as occurred.
	b12 - MFR					A manufacturer specific fault or warning has occurred.
	b11 - POWER_GOOD#					The POWER_GOOD signal is de-asserted.
	b10 - FANS					A fan or airflow fault or warning has occurred.
	b9 - OTHER					Not supported
	b8 - UNKNOWN					Not supported
	b7 - BUSY					A fault was declared because the device was busy and unable to respond.
	b6 - OFF					Unit is OFF.
	b5 - VOUT_OV					Output over-voltage fault has occurred.
	b4 - IOUT_OC					Output over-current fault has occurred.
	b3 - VIN_UV					An input under-voltage fault has occurred.
	b2 - TEMPERATURE					A temperature fault or warning has occurred.
	b1 - CML					A communication, memory or logic fault has occurred.
b0 - NONE_OF_THE_ABOVE					A fault or warning not listed in bits[7:1] of this byte has occurred.	
7Ah	STATUS_VOUT	-	R	1		Output voltage related faults and warnings
	b7					VOUT over-voltage fault
	b6					VOUT over-voltage warning
	b5					VOUT under-voltage warning
	b4					VOUT under-voltage fault
	b3					VOUT_MAX warning. Not supported.
	b2					TON_MAX_FAULT
	b1					TOFF_MAX warning. Not supported.
	b0					Not supported.

PMBus™ SPECIFICATIONS

The DS1200HE-3 Series Supported PMBus™ Command List:

Command Code	Command Name	Default Value	Access Type	Data Bytes	Data Format	Description
7Bh	STATUS_IOUT	00	R	1		Output current related faults and warnings.
	b7					IOUT Over Current Fault
	b6					IOUT Over Current and Low Voltage Shutdown Fault Not supported.
	b5					IOUT Overcurrent Warning
	b4					IOUT Undercurrent Fault Not supported.
	b3					Current Share Fault Not supported.
	b2					Power Limiting. Not supported.
	b1					POUT Overpower Fault Not supported.
	b0					POUT Overpower Warning
7Ch	STATUS_INPUT	-	R	1		Input related faults and warnings.
	b7					VIN Overvoltage Fault
	b6					VIN Overvoltage Warning Not supported.
	b5					VIN Under-voltage Warning
	b4					VIN Under-voltage Fault
	b3					Unit is OFF for insufficient input voltage.
	b2					IIN Over Current Fault
	b1					IIN over current warning Not supported.
	b0					PIN overpower warning Not supported.
7Dh	STATUS_TEMPERATURE	-	R	1		Temperature related faults and warnings.
	b7					Over-temperature Fault
	b6					Over-temperature Warning
	b5					Under-temperature Warning Not supported.
	b4					Under-temperature Fault Not supported.
	b3:0					Reserved
7Eh	STATUS_CML	-	R	1		Communications, logic and memory
	b7					Invalid or unsupported command received.
	b6					Invalid Data
	b5					Packet Error Check Failed
	b4					Memory Fault Detect, CRC Error
	b3					Not supported.
	b2					Not supported.
	b1					Not supported.
		b0				

PMBus™ SPECIFICATIONS

The DS1200HE-3 Series Supported PMBus™ Command List:

Command Code	Command Name	Default Value	Access Type	Data Bytes	Data Format	Description
80h	STATUS_MFR_SPECIFIC	-	R	1		Manufacturer Status Codes
	b7					Not Used
	b6					Not Used
	b5					Not Used
	b4					Not Used
	b3					Not Used
	b2					Not Used
	b1					Not Used
	b0					MFR SPECIFIC FAULT For trouble shooting.
81h	STATUS_FANS_1_2		R	1		
	b7					Fan 1 fault
	b6					Fan 2 fault
	b5					Fan 1 warning
	b4					Fan 2 warning
	b3					Fan 1 speed overridden
	b2					Fan 2 speed overridden
	b1					Not used
b0					Not used	
86h	READ_EIN	-	BR	6	Linear	Returns the accumulated input power over time.
87h	READ_EOUT	-	BR	6	Linear	Returns the accumulated output power over time.
88h	READ_VIN	-	R	2	Linear	Returns input voltage in Volts ac.
89h	READ_IIN	-	R	2	Linear	Returns input current in Amperes.
8Ah	READ_VCAP	-	R	2	Linear	Returns bulk capacitor voltage in Volts.
8Bh	READ_VOUT	-	R	2	Linear	Returns the actual, measured voltage in Volts.
8Ch	READ_IOUT	-	R	2	Linear	Returns the output current in amperes.
8Dh	READ_TEMPERATURE_1	-	R	2	Linear	PFC HTSK_Temp_1 (Standard air mode uses this sensor for fan control)
8Eh	READ_TEMPERATURE_2	-	R	2	Linear	DCDC HTSK_Temp_2
8Fh	READ_TEMPERATURE_3	-	R	2	Linear	SEC Ambient_Temp_3 (Inside temperature. Reverse air mode uses this sensor for fan control)
90h	READ_FAN_SPEED_1	-	R	2	Linear	Speed of fan 1
96h	READ_POUT	-	R	2	Linear	Returns the output power, in Watts.
97h	READ_PIN	-	R	2	Linear	Returns the input power, in Watts.
98h	PMBus™_REVISION	22	R	1	Bitmapped	Reads the PMBus™ revision number
	b7:5	0001				Part 1 Revision 0000 - Revision 1.0 0001 - Revision 1.1
	b4:0	0001				Part 2 Revision 0000 - Revision 1.0 0001 - Revision 1.1

PMBus™ SPECIFICATIONS

The DS1200HE-3 Series Supported PMBus™ Command List:

Command Code	Command Name	Default Value	Access Type	Data Bytes	Data Format	Description
99h	MFR_ID	07, 45, 4D, 45, 52, 53, 4F, 4E	BR, ASCII	7		Abbrev or symbol of manufacturers name. ASCII (artesynt)
9Ah	MFR_MODEL		BR, ASCII	13		Manufacturers Model Number, ASCII format
9Bh	MFR_REVISION	TBD	BR, ASCII	3		Manufacturers Revision Number, ASCII format
9Ch	MFR_LOCATION	0B, 50, 68, 69, 6C, 69, 70, 70, 69, 6E, 65, 73, E0	BR, ASCII	12		Manufacturers Facility, ASCII format
9Dh	MFR_DATE	TBD	BR	7		Manufacture Date, ASCII format structure: YYMMDD
9Eh	MFR_SERIAL	TBD	BR	16		Unit Serial Number, ASCII format.
A0h	MFR_VIN_MIN	EADO	R	2	Linear	Minimum Input Voltage (90Vac)
A1h	MFR_VIN_MAX	FA10	R	2	Linear	Maximum Input Voltage (264Vac)
A2h	MFR_IIN_MAX		R	2	Linear	Maximum Input Current. Depends on model.
A3h	MFR_PIN_MAX	0A33			Linear	Maximum Input Power
A4h	MFR_VOUT_MIN	16CC	R	2	Linear	Minimum Output Voltage Regulation Window. (11.4V)
A5h	MFR_VOUT_MAX	1933	R	2	Linear	Maximum Output Voltage. Regulation Window (12.6V)
A6h	MFR_IOUT_MAX		R	2	Linear	Maximum Output Current Depends on model.
A7h	MFR_POOUT_MAX		R	2	Linear	Maximum Output Power Depends on model.
A8h	MFR_TAMBIENT_MAX	EA30	R	2	Linear	Maximum Operating Ambient Temperature (Secondary Ambient) (50degC)
A9h	MFR_TAMBIENT_MIN	0000	R	2	Linear	Minimum Operating Ambient Temperature (Secondary Ambient) (0degC)
AAh	MFR_EFFICIENCY_LL		BR/W	14	Linear	Vin, %load, Eff, %Load, Eff, %load, Eff.
ABh	MFR_EFFICIENCY_HL		BR/W	14	Linear	Vin, %load, Eff, %Load, Eff, %load, Eff.
D0h	Fault Register		R	2		Summary of units fault and warning status.
	b15 - 12Vout_Sckt					An output short circuit fault has occurred.
	b14 - 12Vout_OCW					+12V Over Current Warning Flag
	b13 - 12Vout_OCP2					+12V fast OCP (High Level OCP) fault occurred (1ms).
	b12 - 12Vout_OCP					+12V normal OCP fault occurred (1sec).
	b11 - 12Vout_OVP2					+12V second level OVP fault occurred.
	b10 - 12Vout_OVP					+12V OVP fault occurred.
	b9 - 12Vout_UVP					+12V UVP fault occurred.
	b8 - NA					Not Used

PMBus™ SPECIFICATIONS

The DS1200HE-3 Series Supported PMBus™ Command List:

Command Code	Command Name	Default Value	Access Type	Data Bytes	Data Format	Description
D0h	b7 - NA					Not Used
	b6 - Ocp_Ride_Through_Flag					PSU is in 1second ride-through because +12V OCP level is reached.
	b5 - Stby_UVP					Standby UVP fault occurred.
	b4 - Fan Fail					A fan or airflow fault or warning has occurred.
	b3 - OTP_Secondary					Secondary OTP (Ambient) fault occurred.
	b2 - OTP_Primary					Primary OTP fault occurred.
	b1 - PwrLimit_Enabled.					PSU is on derated output power.
	b0 - Save Last Known State IFF "1" - default "0"					Saves last known fault that occurred. Under development
D2h	Min Fan Speed	3923	R	2	L	Standby Fan Speed, (13200RPM / 20% Duty Cycle)
D3h	Max Fan Speed	5832	R	2	L	Normal operation Fan Speed (38400RPM / 100% Duty Cycle)
E2h	Ishare Offset		R/W	2		Variable. Used by factory to trim Ishare voltage offset. Default before tirmming, 0000
E3h	Ishare Slope		R/W	2		Variable. Used by factory to trim Ishare voltage slope. Default before tirmming, FF7F
EAh	ENTER_BOOTLOAD		W	2		
EFh	I/O_EXPANDER		R	1		
F0h	PSU_FACTORY_MODE		R	2		
F8h	FW_VERSION_SEC		BR	2	ASCII	

APPLICATION NOTES

Current Sharing

The DS1200HE-3 series main output V_O is equipped with current sharing capability. This will allow up to 4 power supplies to be connected in parallel for higher power application.

When two or more power supplies are connected and operating in parallel and each is delivering 40-50% of its rated output to the load, the power supplies will current share within 5% accuracy. When supplying light loads between 10% and 30% of its rated load, the power supplies will share within 20% accuracy. (Below 10% load, there is no guarantee of output current sharing) If any power supply is hot swapped, no glitch will occur that violates the regulation limits of the power supply defined in this specification.

During 1+1 operation, the stand-by output load will not exceed the maximum load of a single power supply. Any shutdown, load change, extraction, insertion on a PSU at any load condition should not cause the standby output to fall out of the regulation range.

At minimum, a test in 4+1 configuration will be made by using the DSR1U (73-762-003) rack. The PSU must meet all parametric requirements in any load, line, and environmental conditions mentioned in this specification.

Redundancy / Fault Tolerance

The DS1200HE-3 series power supplies can be connected in the following to provide redundancy/fault tolerance operation:

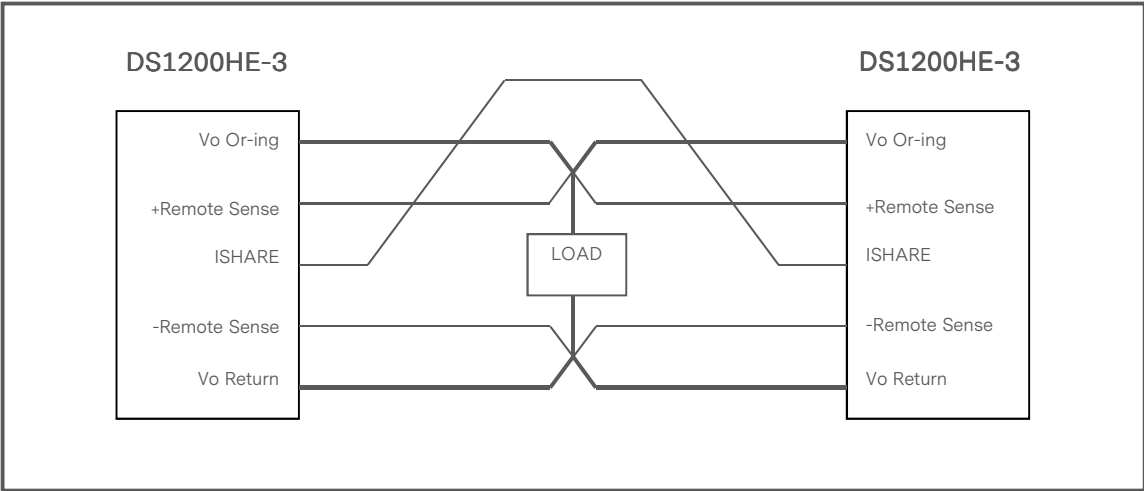

The DS1200HE-3 series power supply will allow up to 4 power supplies to be connected in an N+1 redundant load.

Any failure of one power supply in parallel as well as hot swapping shall not cause more than a 5% change in any output. Current share accuracy is typically 5% of full load. The failure of one or more supplies will not cause the remaining supplies to violate any of the input or output specifications noted in this specification including all status signals.

The latch of the DS1200HE-3 power supply is designed to prevent the latch from depressed if the AC cord is attached to the power supply. In order to remove the power supply from system chassis, the AC cord must be removed first so the power supply will always be in the powered off state during the removal from system chassis.

APPLICATION NOTES

Output Ripple and Noise Measurement

The setup outlined in the diagram below has been used for output voltage ripple and noise measurements on the DS1200HE-3 series. When measuring output ripple and noise, a scope jack in parallel with a 0.1 μ F ceramic chip capacitor, and a 10 μ F tantalum capacitor will be used. Oscilloscope can be set to 20MHz bandwidth for this measurement.

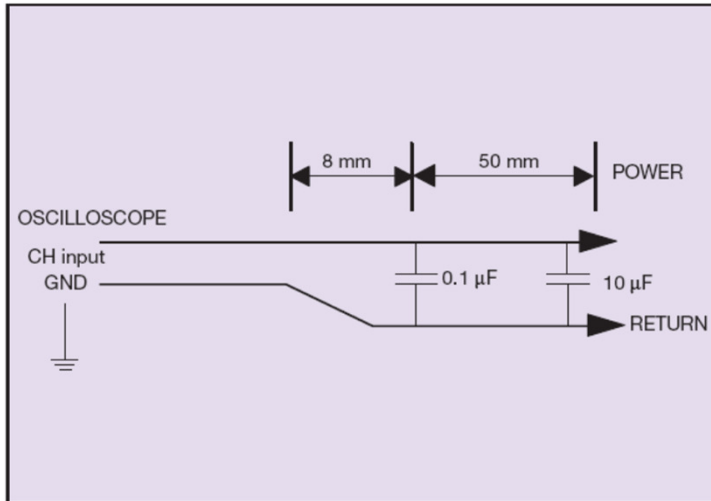

RECORD OF REVISION AND CHANGES

Issue	Date	Description	Originators
1.0	04.30.2014	First issue	K. Wang
1.1	05.05.2014	Update the error	K. Wang
1.2	08.26.2016	Update the FRU address	K. Wang
1.3	11.17.2016	Update the comment list	K. Wang
1.4	03.04.2020	Update main to main and standby on first page	K. Wang
1.5	04.20.2020	Update the FRU address	K. Wang
1.6	03.04.2021	Update cover and back cover	C. Liu



For international contact information,
visit advancedenergy.com.

powersales@aei.com (Sales Support)
productsupport.ep@aei.com (Technical Support)
+1 888 412 7832

ABOUT ADVANCED ENERGY

Advanced Energy (AE) has devoted more than three decades to perfecting power for its global customers. AE designs and manufactures highly engineered, precision power conversion, measurement and control solutions for mission-critical applications and processes.

Our products enable customer innovation in complex applications for a wide range of industries including semiconductor equipment, industrial, manufacturing, telecommunications, data center computing, and medical. With deep applications know-how and responsive service and support across the globe, we build collaborative partnerships to meet rapid technological developments, propel growth for our customers, and innovate the future of power.

PRECISION | POWER | PERFORMANCE

Specifications are subject to change without notice. Not responsible for errors or omissions. ©2020 Advanced Energy Industries, Inc. All rights reserved. Advanced Energy®, and AE® are U.S. trademarks of Advanced Energy Industries, Inc.