

# ARTESYN ERM 150W SERIES

## DC/DC converter



### PRODUCT DESCRIPTION

Advanced Energy's Artesyn ERM150 series is a new generation of high performance, isolated dc-dc converter modules. The product offers 150W in a small, fully encapsulated package. The input voltage ranges comply with European railway standard EN50155. Reinforced insulation and high EMC immunity qualifies these converters also for many demanding applications in railway and other transportation systems.

Advanced circuit topology provides a very high efficiency up to 90% which allows ambient temperatures range up to +85°C with derating.

### SPECIAL FEATURES

- Small 58.4 x 37.3 x17 mm package
- 36 to 160 Vdc wide-range input
- High efficiency up to 90%
- Base-plate optimized for contact cooling or heatsink mounting
- No minimum load requirement
- Fixed switching frequency
- High reliability
- RoHS 3.0 compliant
- UL94 V-0 materials
- DOSA quarter-brick footprint compliant
- Heatsink version available
- Operating temperature -40 to +85°C (subject to derating)
- EN 61373; Vibration and thermal shock
- 3 years warranty

### SAFETY

- TUV EN 62368  
EN 50155
- UL UL 62368-1
- TUV CB IEC 62368-1  
IEC 60571
- CE and UKCA Mark

### TYPICAL APPLICATIONS

- Railway

### AT A GLANCE

#### Total Power

150 Watts

#### Input Voltage

36 to 160 Vdc

#### # of Outputs

Single



## MODEL NUMBERS

Model	Input Voltage	Output Voltage	Minimum Load	Maximum Load	Efficiency
ERM30A100	36-160Vdc	5Vdc	0A	27A	90%
ERM12B100	36-160Vdc	12Vdc	0A	12.5A	90%
ERM10C100	36-160Vdc	15Vdc	0A	10A	89%
ERM6H100	36-160Vdc	24Vdc	0A	6.25A	88%
ERM02U100	36-160Vdc	54Vdc	0A	2.78A	88.5%

### Options

Negative enable (N)

Heatsink (-HS)

## ELECTRICAL SPECIFICATIONS

### Absolute Maximum Ratings

Stress in excess of those listed in the “Absolute Maximum Ratings” may cause permanent damage to the power supply. These are stress ratings only and functional operation of the unit is not implied at these or any other conditions above those given in the operational sections of this TRN. Exposure to any absolute maximum rated condition for extended periods may adversely affect the power supply’s reliability.

Table 1. Absolute Maximum Ratings						
Parameter	Model	Symbol	Min	Typ	Max	Unit
Input Voltage Non-operating - 100mS	All models	$V_{IN,DC}$	-0.7	-	170	Vdc
Maximum Output Power	All models	$P_{O,max}$	-	-	150	W
Isolation Resistance 500Vdc	All models		10	-	-	Gohm
I/O Isolation Capacitance 100KHz, 1V	All models		-	-	2000	pF
Isolation Voltage						
Input to output	All models		2000	-	-	Vac
Input to case	All models		1500	-	-	Vac
Output to case	All models		500	-	-	Vac
Operating Ambient Temperature (With derating, refer to derating curve)	All models	$T_A$	-40	-	+85	°C
Operating Base-plate Temperature Range	All models		-40	-	+105	°C
Storage Temperature	All models	$T_{STG}$	-50	-	+125	°C
Fire protection test	Compliance to EN45545-2					
Humidity (non-condensing)	All models		5	-	95	%
MTBF (MIL-HDBK-217F@25°C, Full load, Ground Benign)	All models		412,541	-	-	Hours

## ELECTRICAL SPECIFICATIONS

## Input Specifications

Table 2. Input Specifications							
Parameter	Conditions	Symbol	Min	Typ	Max	Unit	
Operating Input Voltage, DC	All	$V_{IN,DC}$	36	110	160	Vdc	
Turn-on Voltage Threshold	All	$V_{IN,ON}$	-	-	36	Vdc	
Turn-off Voltage Threshold	All	$V_{IN,OFF}$	-	35	-	Vdc	
Maximum Input Current	ERM30A100 ERM12B100 ERM10C100 ERM6H100 ERM02U100	$V_{IN,DC} = V_{IN,nom}$ $I_O = I_{O,max}$	$I_{IN,max}$	- - - - -	1.364 1.515 1.532 1.550 1.542	- - - - -	A
No Load Input Current		$V_{IN,DC} = V_{IN,nom}$	$I_{IN,no\_load}$	-	10	-	mA
Efficiency @Max. Load	ERM30A100 ERM12B100 ERM10C100 ERM6H100 ERM02U100	$V_{IN,DC} = V_{IN,nom}$ $I_O = I_{O,max}, T_A = 25^{\circ}C$	$\eta$	- - - - -	90 90 89 88 88.5	- - - - -	%
Start Up Time				-	50	-	mS
Internal Filter Type	Internal Capacitor						

## ELECTRICAL SPECIFICATIONS

## Output Specifications

Table 3. Output Specifications							
Parameter		Conditions	Symbol	Min	Typ	Max	Unit
Factory Set Voltage		$V_{IN,DC} = V_{IN,nom}$ $I_O = I_{O,max}, T_A = 25^{\circ}C$	$V_O$	-1	-	1	%
Line Regulation		$V_{IN,DC} = V_{IN,min}$ to $V_{IN,max}$	$V_O$	-0.2	-	0.2	%
Load Regulation		$I_O = I_{O,min}$ to $I_{O,max}$	$V_O$	-0.3	-	0.3	%
Output Current	ERM30A100	Convection Cooling	$I_O$	-	-	27	A
	ERM12B100			-	-	12.5	
	ERM10C100			-	-	10	
	ERM6H100			-	-	6.25	
	ERM02U100			-	-	2.78	
Load Capacitance	ERM30A100	Start up	$C_O$	-	-	51000	uF
	ERM12B100			-	-	8850	
	ERM10C100			-	-	5700	
	ERM6H100			-	-	2200	
	ERM02U100			-	-	550	
Output Voltage Trim Range	Other Models	All	$V_O$	-10	-	10	%
	54V Output		$V_O$	-15	-	5	%
Switching Frequency	Other Models	All	$f_{SW}$	-	200	-	KHz
	54V Output	All	$f_{SW}$	-	180	-	KHz
Temperature Coefficient		All	$\%V_O$	-	-	0.02	$\%/^{\circ}C$
Output Over Current Protection		All	$\%I_{O,max}$	-	130	-	%
Output Temperature Protection (Baseplate)		All	$T_{Baseplate}$	-	110	-	$^{\circ}C$
Output Short Circuit Protection		All	Hiccup Mode 0.3Hz type, Automatic Recovery				
Output Ripple, pk-pk	ERM30A100	20MHz bandwidth	$V_O$	-	100	-	$mV_{PK-PK}$
	ERM12B100				150		
	ERM10C100				150		
	ERM6H100				200		
	ERM02U100				300		
Output Over Voltage Protection	ERM30A100	All	$V_O$	-	6.2	-	Vdc
	ERM12B100			-	15	-	
	ERM10C100			-	18	-	
	ERM6H100			-	30	-	
	ERM02U100			-	66	-	
V <sub>O</sub> Dynamic Response		25% load change	$\pm\%V_O$ $T_s$	-	3	5	% uSec
Peak Deviation Recovery Time				-	250	-	

# ELECTRICAL SPECIFICATIONS

## ERM30A100 Performance Curves

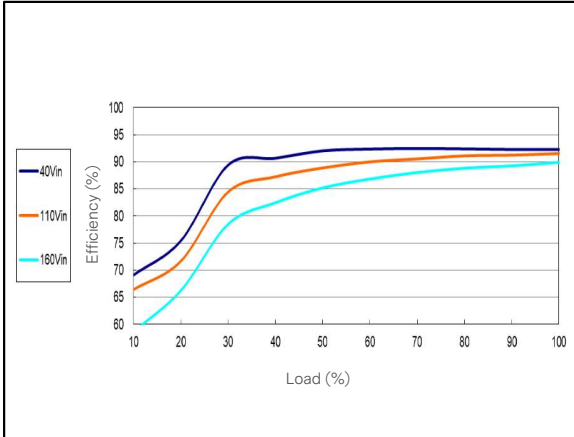

Figure 1: ERM30A100 Efficiency Versus Output Current Curve  
 Vin = 40 to 160 Vdc Load: Io = 0 to 27 A

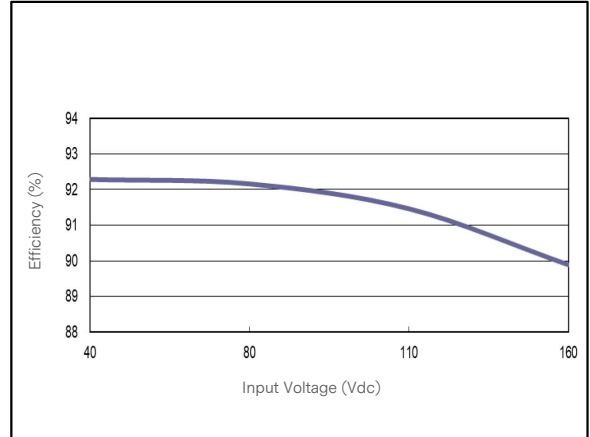

Figure 2: ERM30A100 Efficiency Versus Input Voltage Curve  
 Vin = 40 to 160 Vdc Load: Io = 0 to 27 A

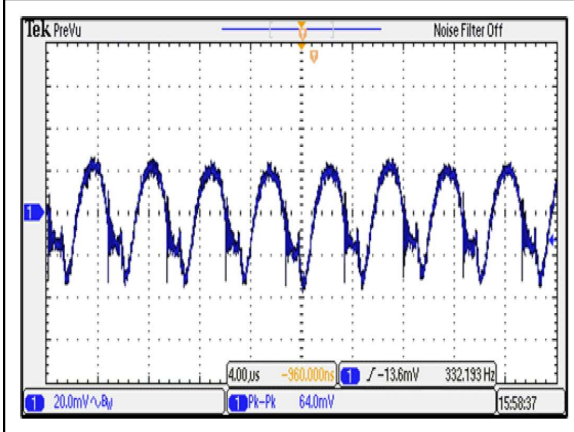

Figure 3: ERM30A100 Typical Output Ripple and Noise  
 Vin = 50Vdc Load: Io = 27A  
 Ch 1: Vo

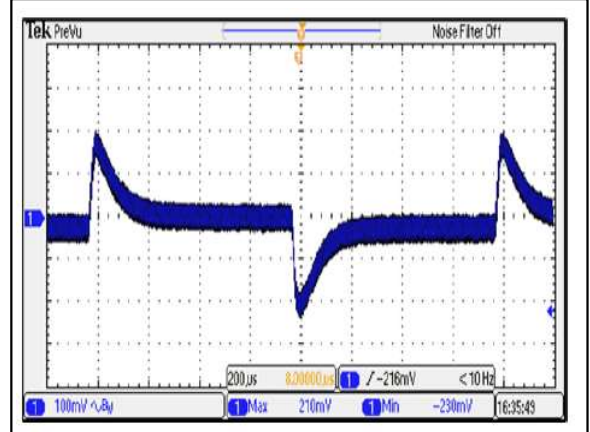

Figure 4: ERM30A100 Transient Response  
 Vin = 50Vdc Load: Io = 100% to 75% load change  
 Ch 1: Vo

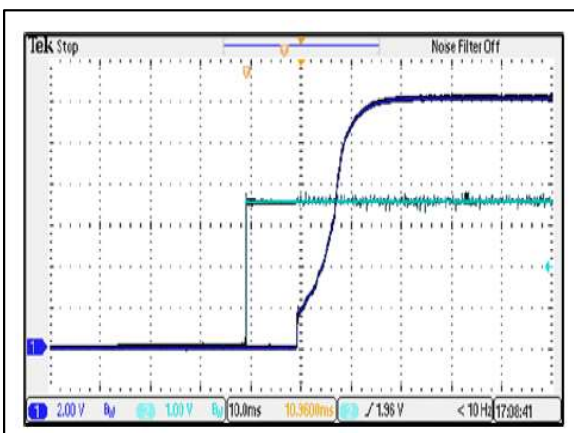

Figure 5: ERM30A100 Output Voltage Startup Characteristic by On/Off  
 Vin = 50Vdc Load: Io = 27A  
 Ch 1: Vo Ch 2: Remote On/Off

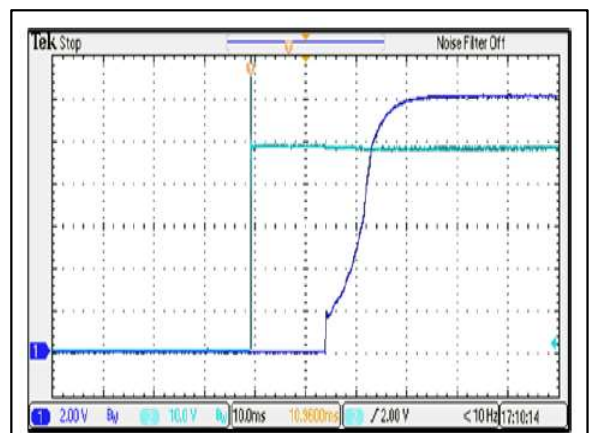

Figure 6: ERM30A100 Output Voltage Startup Characteristic by Vin  
 Vin = 50Vdc Load: Io = 27A  
 Ch 1: Vo Ch 2: Vin

# ELECTRICAL SPECIFICATIONS

## ERM30A100 Performance Curves

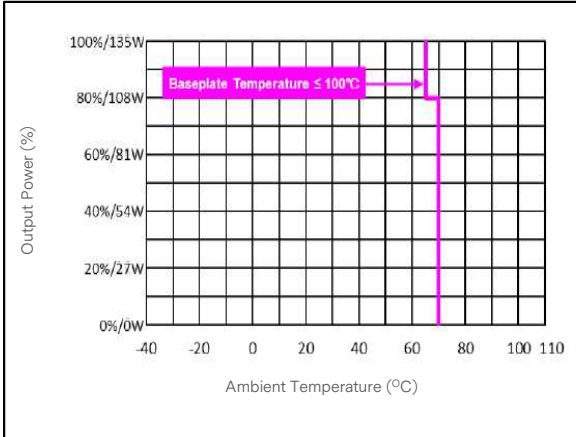

Figure 7: ERM30A100 Derating Curve without Heatsink  
 Vin = 110Vdc Load: Io = 0 to 27 A

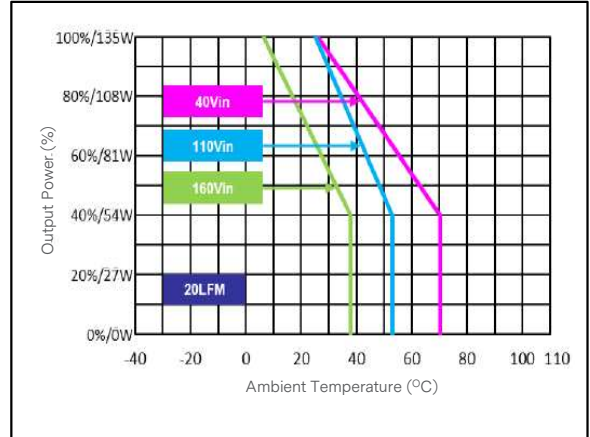

Figure 8: ERM30A100 Derating Curve with HS7 Heatsink  
 Vin = 40 to 160 Vdc Load: Io = 0 to 27 A

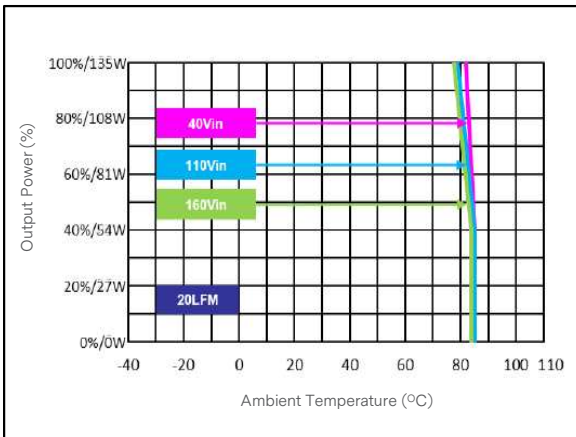

Figure 9: ERM30A100 Derating Curve with 3U iron back-plate  
 (Dimension 482X133.5X1.6mm)  
 Vin = 40 to 160 Vdc Load: Io = 0 to 27 A

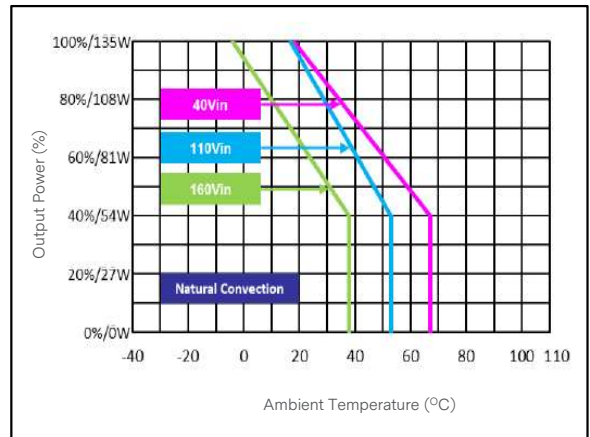

Figure 10: ERM30A100 Derating Curve with HS7 Heatsink  
 Vin = 40 to 160 Vdc Load: Io = 0 to 27 A

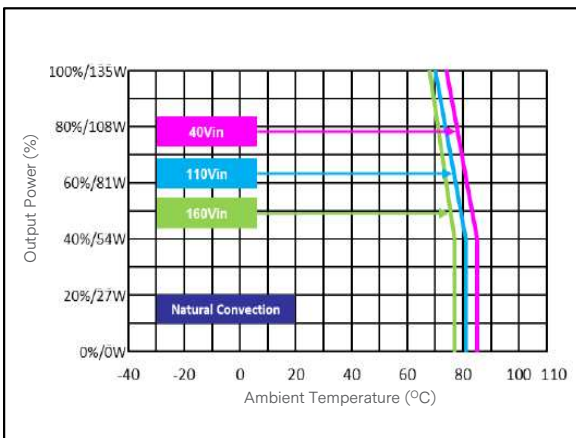

Figure 11: ERM30A100 Derating Curve with 3U iron back-plate  
 (Dimension 482X133.5X1.6mm)  
 Vin = 40 to 160 Vdc Load: Io = 0 to 27 A

# ELECTRICAL SPECIFICATIONS

## ERM12B100 Performance Curves

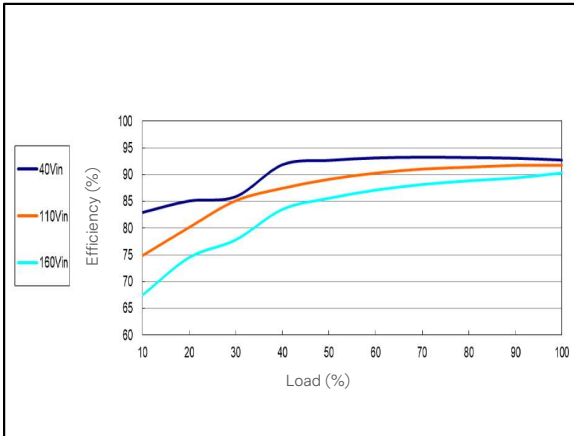

Figure 12: ERM12B100 Efficiency Versus Output Current Curve  
 Vin = 40 to 160 Vdc Load: Io = 0 to 12.5 A

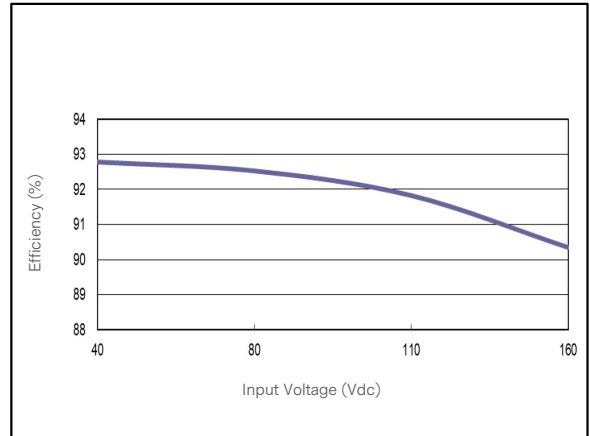

Figure 13: ERM12B100 Efficiency Versus Input Voltage Curve  
 Vin = 40 to 160 Vdc Load: Io = 0 to 12.5 A

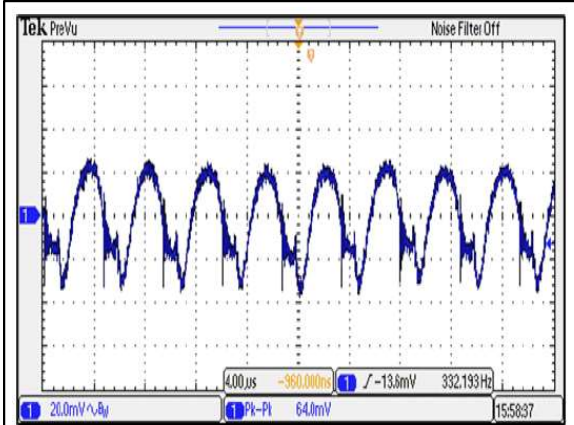

Figure 14: ERM12B100 Typical Output Ripple and Noise  
 Vin = 50Vdc Load: Io = 12.5A  
 Ch 1: Vo

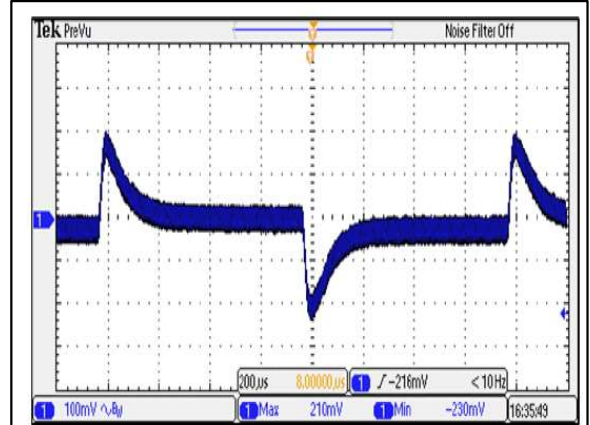

Figure 15: ERM12B100 Transient Response  
 Vin = 50Vdc Load: Io = 100% to 75% load change  
 Ch 1: Vo

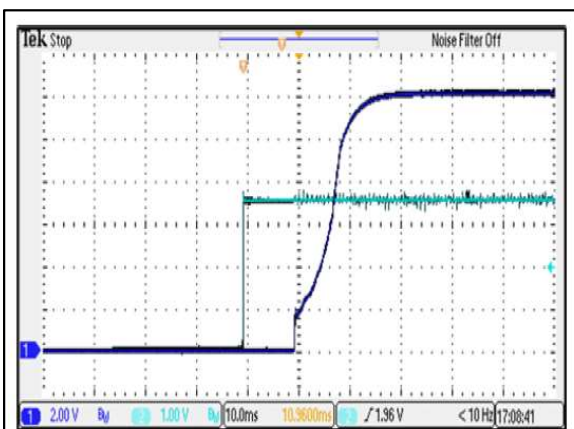

Figure 16: ERM12B100 Output Voltage Startup Characteristic by On/Off  
 Vin = 50Vdc Load: Io = 12.5A  
 Ch 1: Vo Ch 2: Remote On/Off

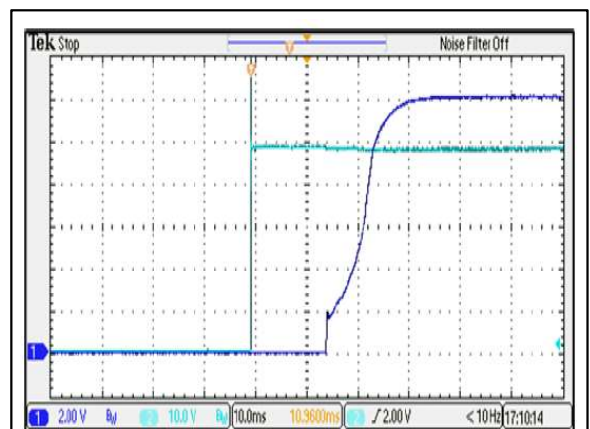

Figure 17: ERM12B100 Output Voltage Startup Characteristic by Vin  
 Vin = 50Vdc Load: Io = 12.5A  
 Ch 1: Vo Ch 2: Vin



# ELECTRICAL SPECIFICATIONS

## ERM12B100 Performance Curves

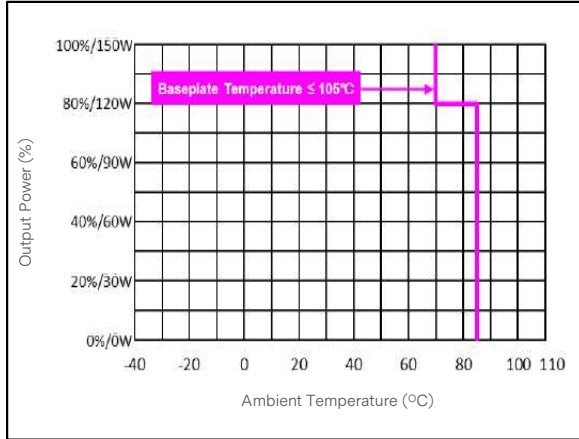

Figure 18: ERM12B100 Derating Curve without Heatsink  
 Vin = 110Vdc Load: Io = 0 to 12.5 A

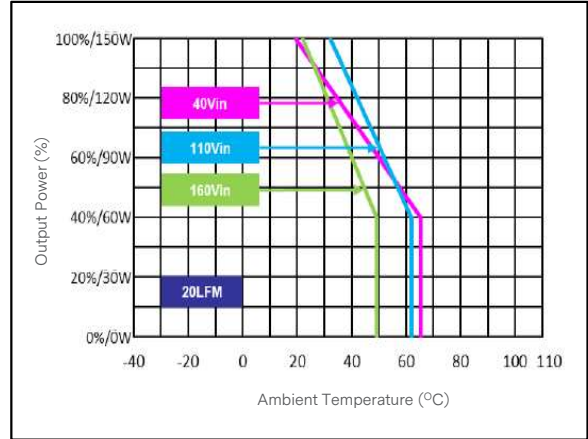

Figure 19: ERM12B100 Derating Curve with HS7 Heatsink  
 Vin = 40 to 160 Vdc Load: Io = 0 to 12.5 A

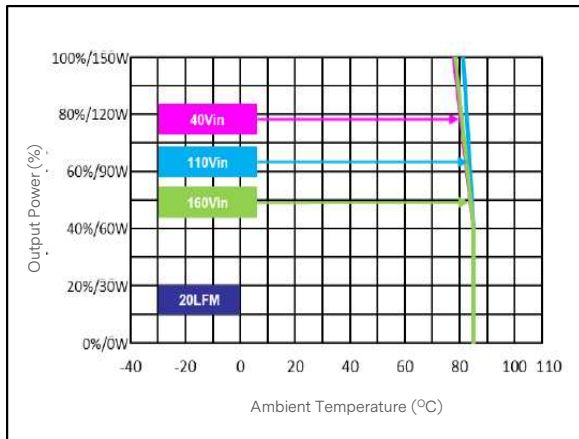

Figure 20: ERM12B100 Derating Curve with 3U iron back-plate  
 (Dimension 482X133.5X1.6mm)  
 Vin = 40 to 160 Vdc Load: Io = 0 to 12.5 A

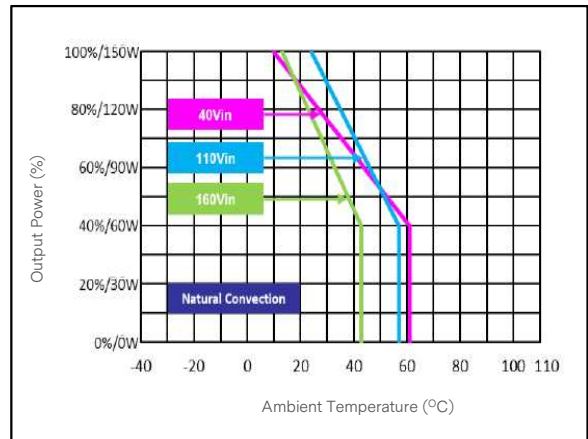

Figure 21: ERM12B100 Derating Curve with HS7 Heatsink  
 Vin = 40 to 160 Vdc Load: Io = 0 to 12.5 A

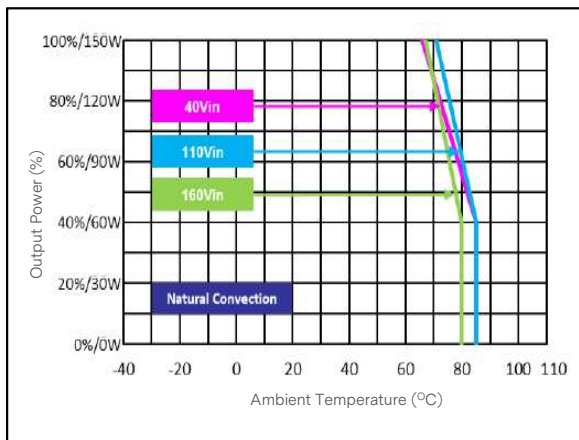

Figure 22: ERM12B100 Derating Curve with 3U iron back-plate  
 (Dimension 482X133.5X1.6mm)  
 Vin = 40 to 160 Vdc Load: Io = 0 to 12.5 A

# ELECTRICAL SPECIFICATIONS

## ERM10C100 Performance Curves

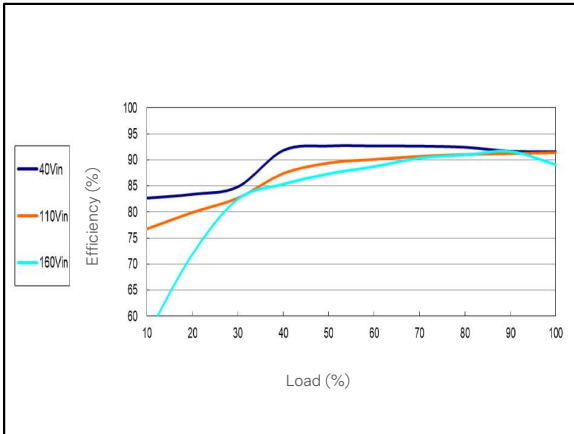

Figure 23: ERM10C100 Efficiency Versus Output Current Curve  
 Vin = 40 to 160 Vdc Load: Io = 0 to 10 A

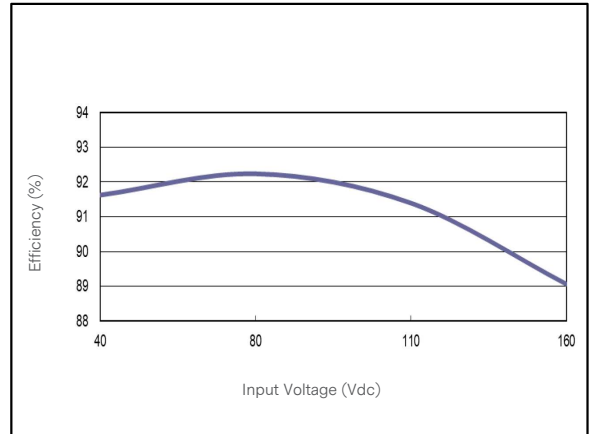

Figure 24: ERM10C100 Efficiency Versus Input Voltage Curve  
 Vin = 40 to 160 Vdc Load: Io = 0 to 10 A

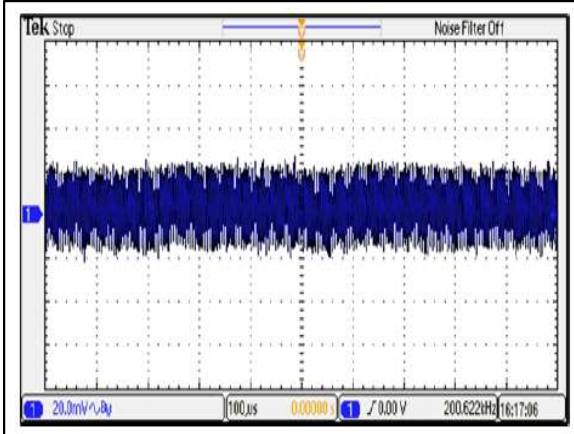

Figure 25: ERM10C100 Typical Output Ripple and Noise  
 Vin = 110Vdc Load: Io = 10A  
 Ch 1: Vo

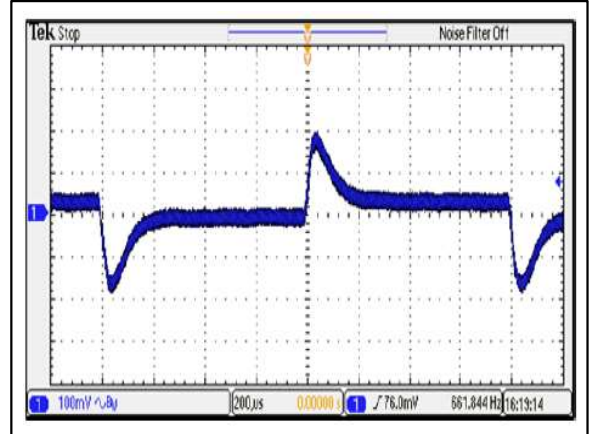

Figure 26: ERM10C100 Transient Response  
 Vin = 110Vdc Load: Io = 100% to 75% load change  
 Ch 1: Vo

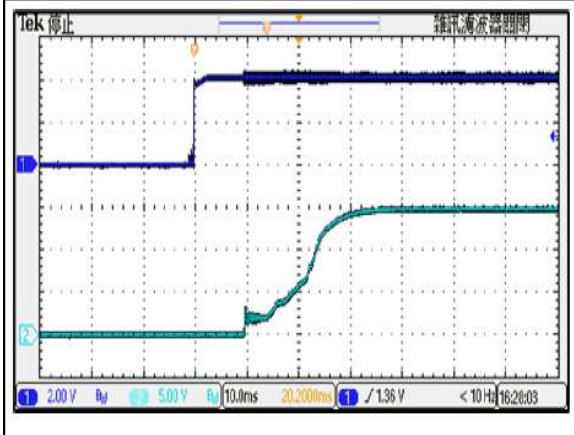

Figure 27: ERM10C100 Output Voltage Startup Characteristic by On/Off  
 Vin = 110Vdc Load: Io = 10A  
 Ch 1: Remote On/Off Ch 2: Vo

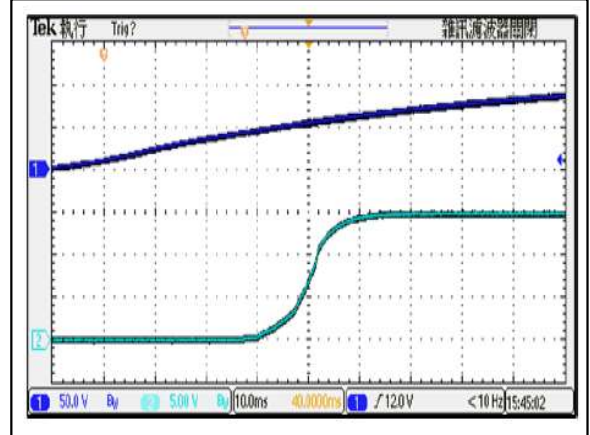

Figure 28: ERM10C100 Output Voltage Startup Characteristic by Vin  
 Vin = 110Vdc Load: Io = 10A  
 Ch 1: Vin Ch 2: Vo

# ELECTRICAL SPECIFICATIONS

## ERM10C100 Performance Curves

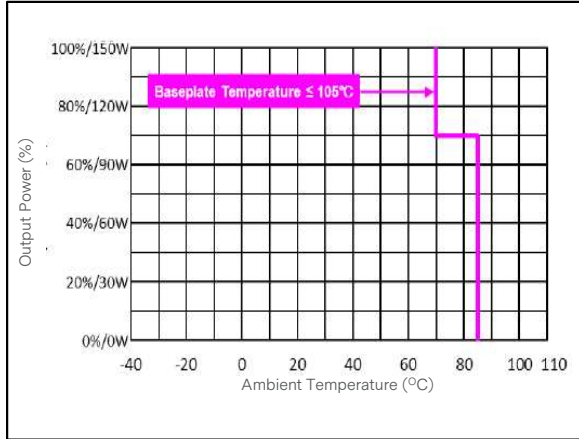

Figure 29: ERM10C100 Derating Curve without Heatsink  
 Vin = 110Vdc Load: Io = 0 to 10 A

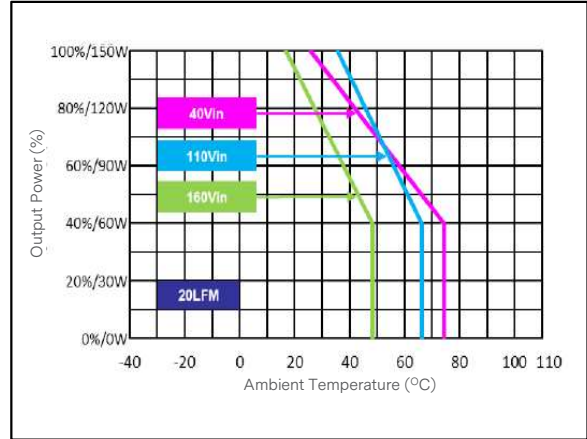

Figure 30: ERM10C100 Derating Curve with HS7 Heatsink  
 Vin = 40 to 160 Vdc Load: Io = 0 to 10 A

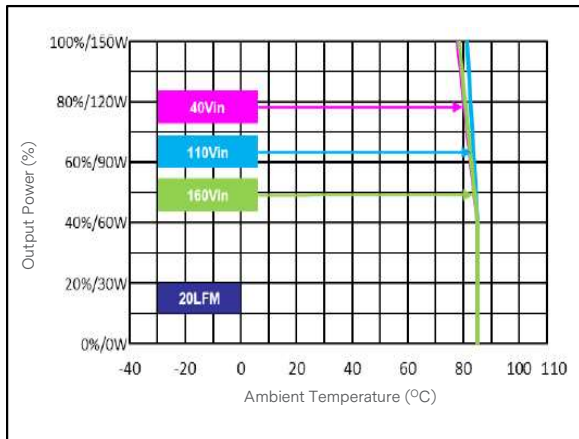

Figure 31: ERM10C100 Derating Curve with 3U iron back-plate  
 (Dimension 482X133.5X1.6mm)  
 Vin = 40 to 160 Vdc Load: Io = 0 to 10 A

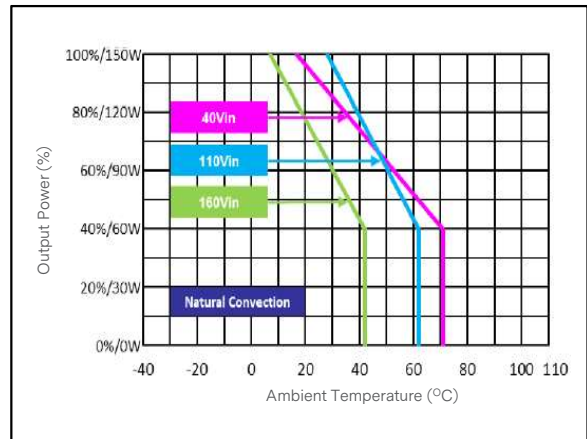

Figure 32: ERM10C100 Derating Curve with HS7 Heatsink  
 Vin = 40 to 160 Vdc Load: Io = 0 to 10 A

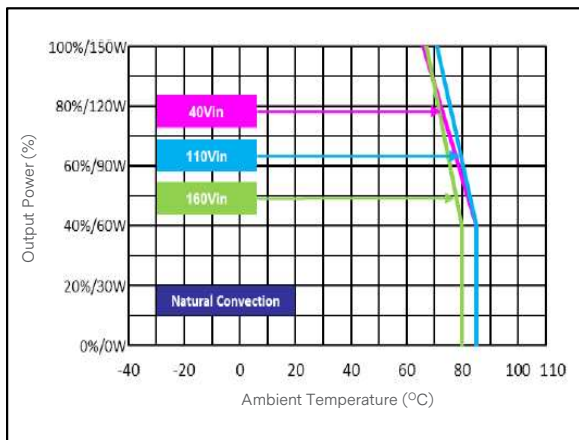

Figure 33: ERM10C100 Derating Curve with 3U iron back-plate  
 (Dimension 482X133.5X1.6mm)  
 Vin = 40 to 160 Vdc Load: Io = 0 to 10 A

# ELECTRICAL SPECIFICATIONS

## ERM6H100 Performance Curves

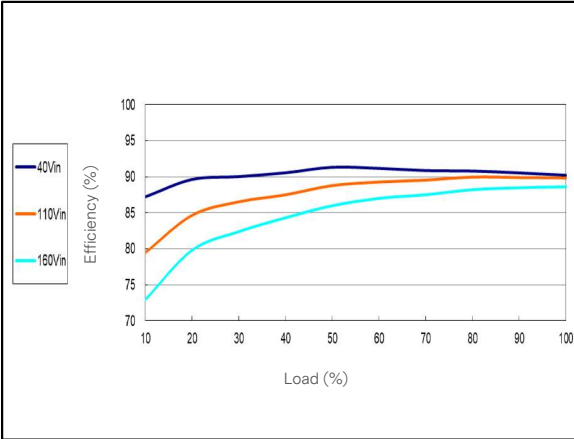

Figure 34: ERM6H100 Efficiency Versus Output Current Curve  
 Vin = 40 to 160 Vdc Load: Io = 0 to 6.25 A

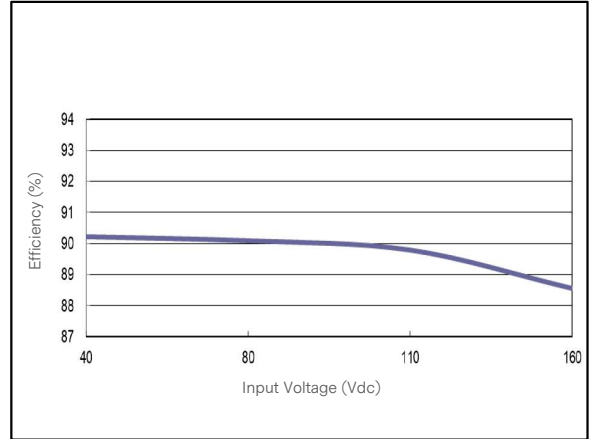

Figure 35: ERM6H100 Efficiency Versus Input Voltage Curve  
 Vin = 40 to 160Vdc Load: Io = 0 to 6.25 A

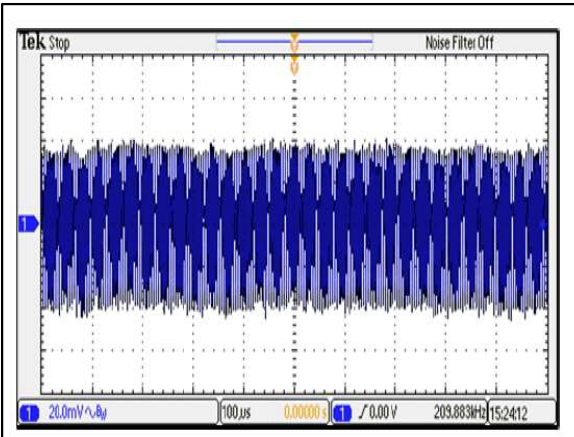

Figure 36: ERM6H100 Typical Output Ripple and Noise  
 Vin = 110Vdc Load: Io = 6.25A  
 Ch 1: Vo

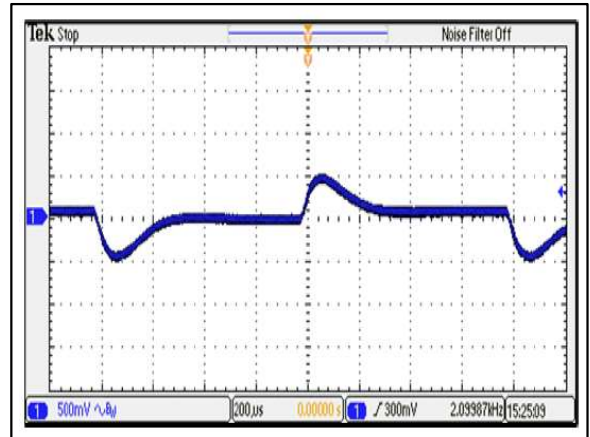

Figure 37: ERM6H100 Transient Response  
 Vin = 110Vdc Load: Io = 100% to 75% load change  
 Ch 1: Vo

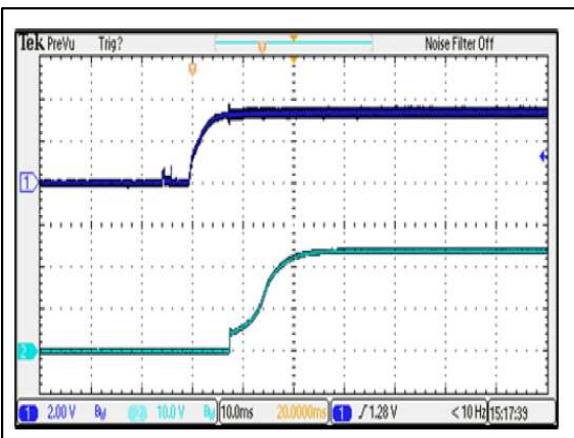

Figure 38: ERM6H100 Output Voltage Startup Characteristic by On/Off  
 Vin = 110Vdc Load: Io = 6.25A  
 Ch 1: Remote On/Off Ch 2: Vo

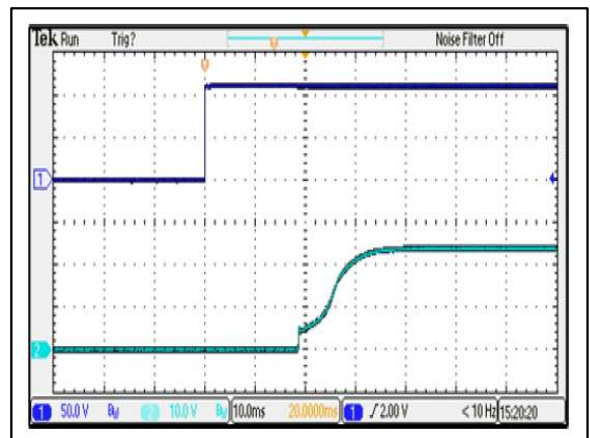

Figure 39: ERM6H100 Output Voltage Startup Characteristic by Vin  
 Vin = 110Vdc Load: Io = 6.25A  
 Ch 1: Vin Ch 2: Vo



# ELECTRICAL SPECIFICATIONS

## ERM6H100 Performance Curves

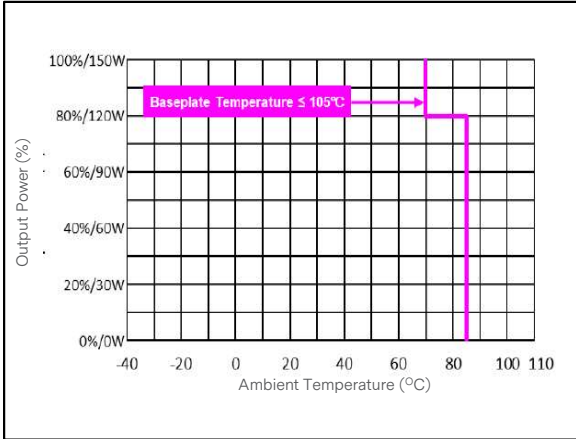

Figure 40: ERM6H100 Derating Curve without Heatsink  
 Vin = 110Vdc Load: Io = 0 to 6.25 A

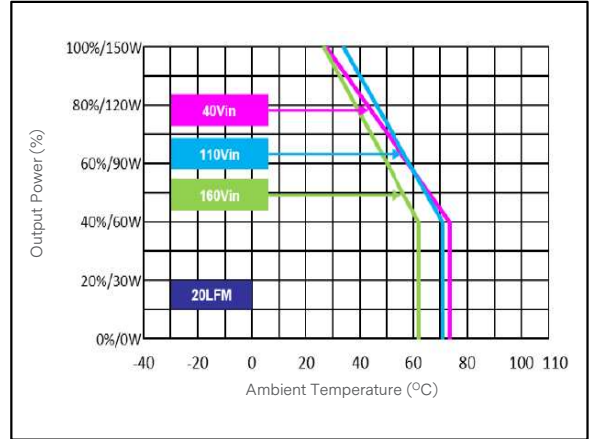

Figure 41: ERM6H100 Derating Curve with HS7 Heatsink  
 Vin = 40 to 160 Vdc Load: Io = 0 to 6.25 A

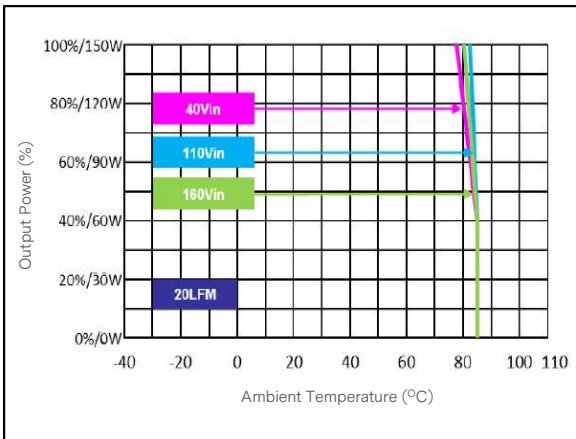

Figure 42: ERM6H100 Derating Curve with 3U iron back-plate  
 (Dimension 482X133.5X1.6mm)  
 Vin = 40 to 160 Vdc Load: Io = 0 to 6.25 A

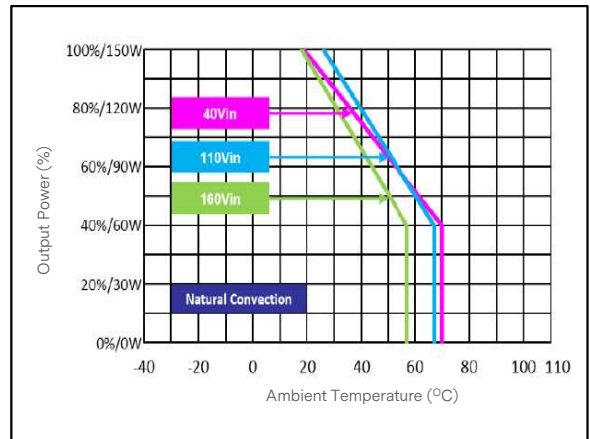

Figure 43: ERM6H100 Derating Curve with HS7 Heatsink  
 Vin = 40 to 160 Vdc Load: Io = 0 to 6.25 A

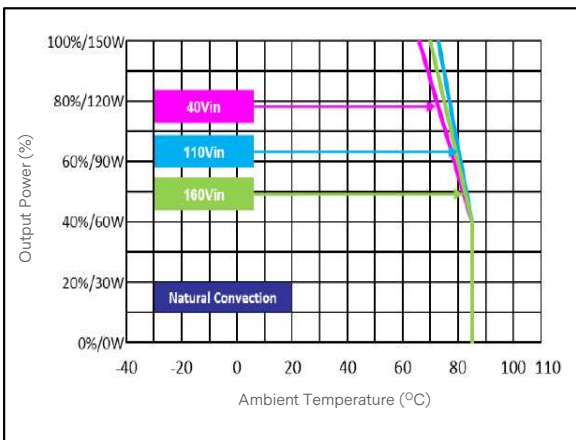

Figure 44: ERM6H100 Derating Curve with 3U iron back-plate  
 (Dimension 482X133.5X1.6mm)  
 Vin = 40 to 160 Vdc Load: Io = 0 to 6.25 A

# ELECTRICAL SPECIFICATIONS

## ERM02U100 Performance Curves

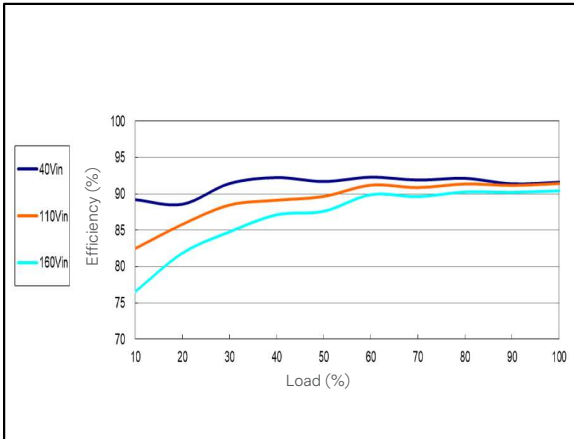

Figure 45: ERM02U100 Efficiency Versus Output Current Curve  
 Vin = 40 to 160 Vdc Load: Io = 0 to 2.78 A

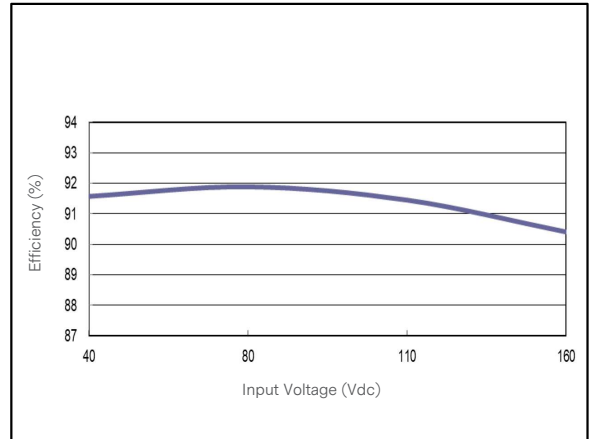

Figure 46: ERM02U100 Efficiency Versus Input Voltage Curve  
 Vin = 40 to 160 Vdc Load: Io = 0 to 2.78 A

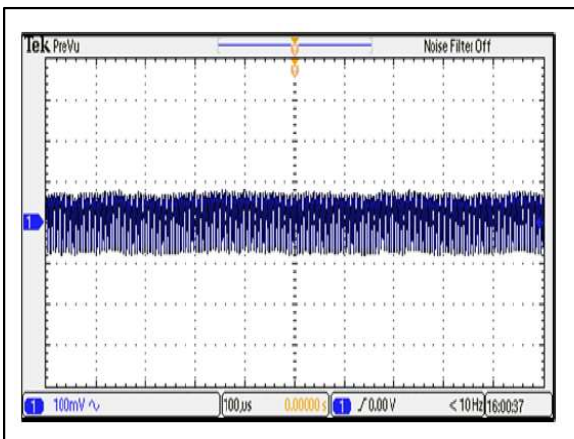

Figure 47: ERM02U100 Typical Output Ripple and Noise  
 Vin = 110Vdc Load: Io = 2.78A  
 Ch 1: Vo

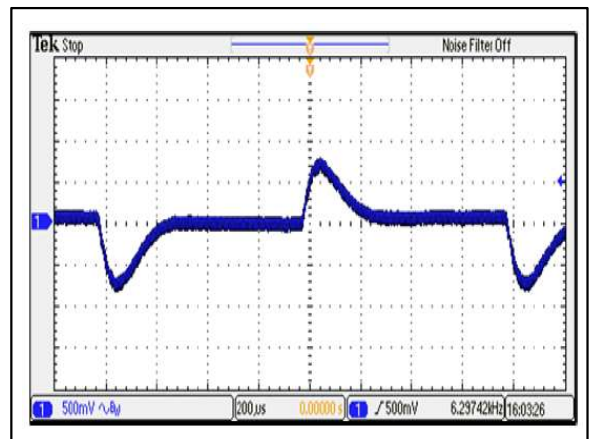

Figure 48: ERM02U100 Transient Response  
 Vin = 110Vdc Load: Io = 100% to 75% load change  
 Ch 1: Vo

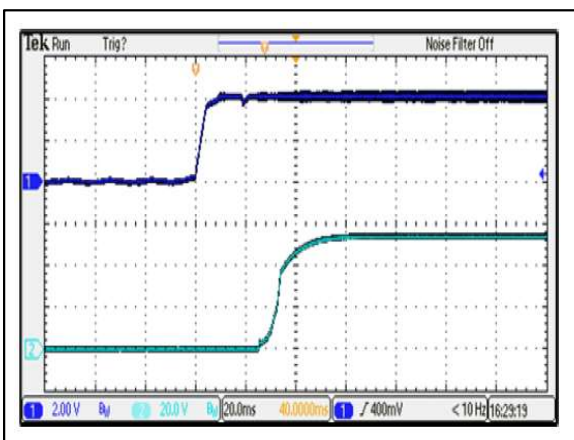

Figure 49: ERM02U100 Output Voltage Startup Characteristic by On/Off  
 Vin = 110Vdc Load: Io = 2.78A  
 Ch 1: Remote On/Off Ch 2: Vo

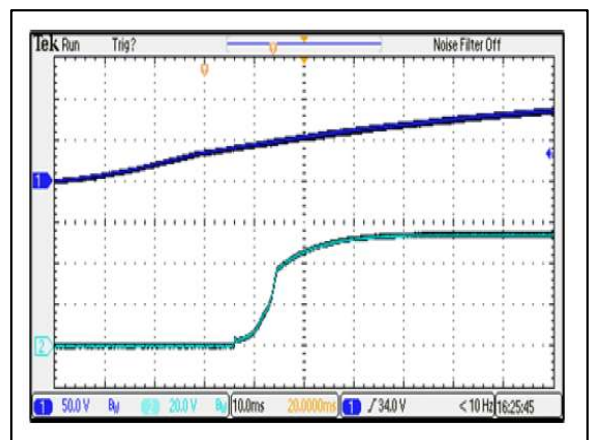

Figure 50: ERM02U100 Output Voltage Startup Characteristic by Vin  
 Vin = 110Vdc Load: Io = 2.78A  
 Ch 1: Vin Ch 2: Vo

# ELECTRICAL SPECIFICATIONS

## ERM02U100 Performance Curves

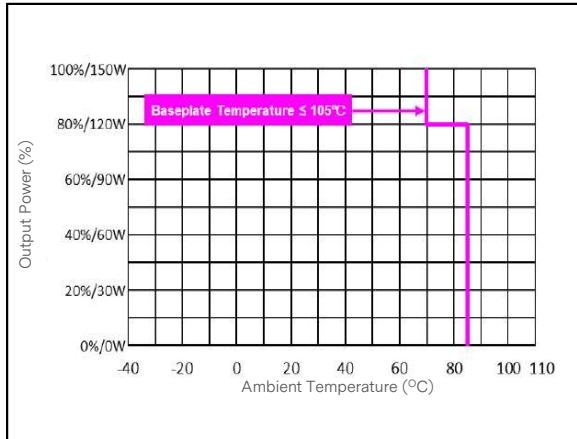

Figure 51: ERM02U100 Derating Curve without Heatsink  
 Vin = 110Vdc Load: Io = 0 to 2.78 A

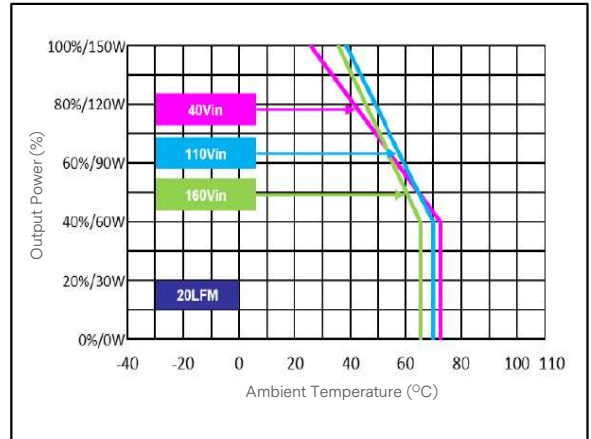

Figure 52: ERM02U100 Derating Curve with HS7 Heatsink  
 Vin = 40 to 160 Vdc Load: Io = 0 to 2.78 A

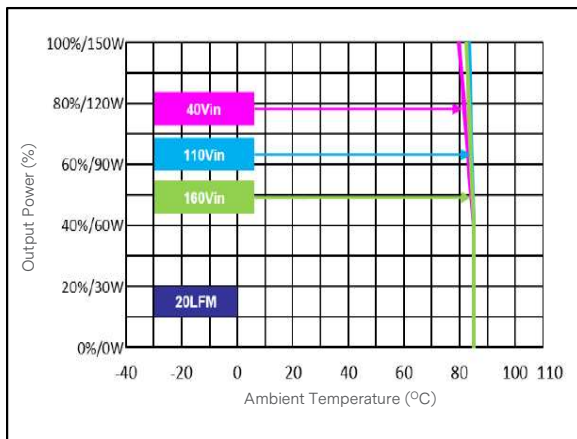

Figure 53: ERM02U100 Derating Curve with 3U iron back-plate  
 (Dimension 482X133.5X1.6mm)  
 Vin = 40 to 160 Vdc Load: Io = 0 to 2.78 A

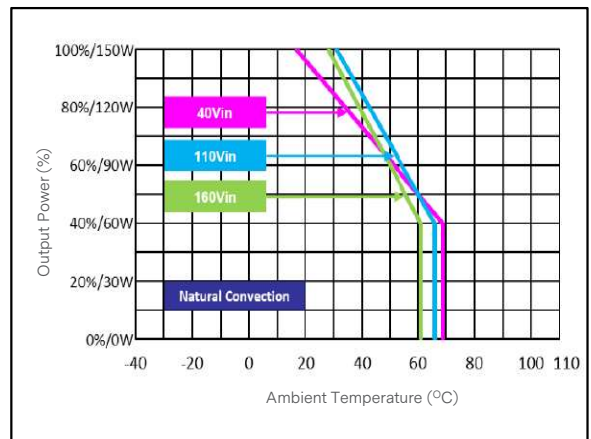

Figure 54: ERM02U100 Derating Curve with HS7 Heatsink  
 Vin = 40 to 160 Vdc Load: Io = 0 to 2.78 A

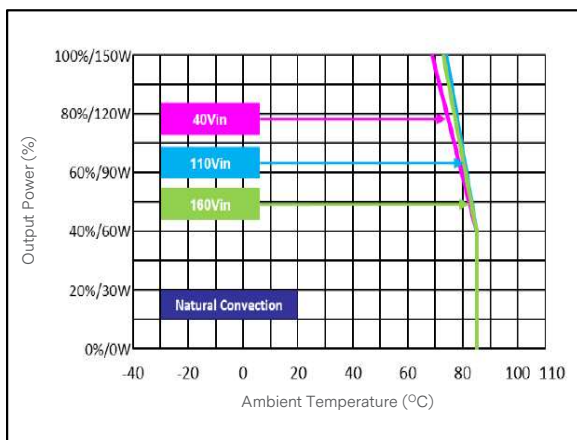
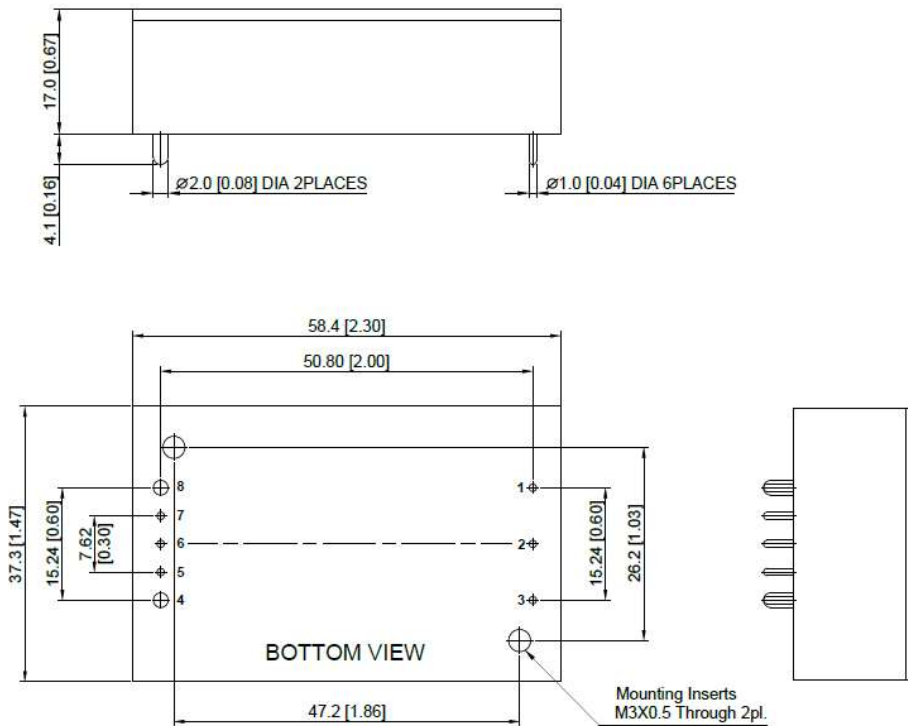

Figure 55: ERM02U100 Derating Curve with 3U iron back-plate  
 (Dimension 482X133.5X1.6mm)  
 Vin = 40 to 160 Vdc Load: Io = 0 to 2.78 A

## MECHANICAL SPECIFICATIONS

### Mechanical Outlines



### Pin Connections

Pin 1	- +Vin
Pin 2	- Remote On/Off
Pin 3	- -Vin
Pin 4	- -Vout
Pin 5	- -Sense
Pin 6	- Trim
Pin 7	- +Sense
Pin 8	- +Vout

#### Note:

- If remote sense not used, the +sense should be connected to +output and -sense should be connected to -output.
- All dimensions in mm (inches)  
Tolerance:  $X.X \pm 0.5$  ( $X.XX \pm 0.02$ )  
 $X.XX \pm 0.25$  ( $X.XXX \pm 0.01$ )
- Pin diameter:  $1.0 \pm 0.05$  ( $0.04 \pm 0.002$ )
- Pin diameter:  $1.5 \pm 0.05$  ( $0.06 \pm 0.002$ )

### Physical Characteristics

Case Size	58.4x37.3x17.0 mm (2.30x1.47x0.67 inches)
Case Material <sup>1</sup>	Plastic resin (flammability to UL 94V-0 rated)
Top Side Base Material <sup>2</sup>	Aluminum Plate
Potting Material	Silicone (UL94-V0)
Weight	110g

Note1: The case material is plastic resin, there is no electrical connection.

Note2: The Top Side Base Material is an aluminum plate, which has electrical connections.



# MECHANICAL SPECIFICATIONS

## Mechanical Outlines – Heatsink

ERM 150W Series

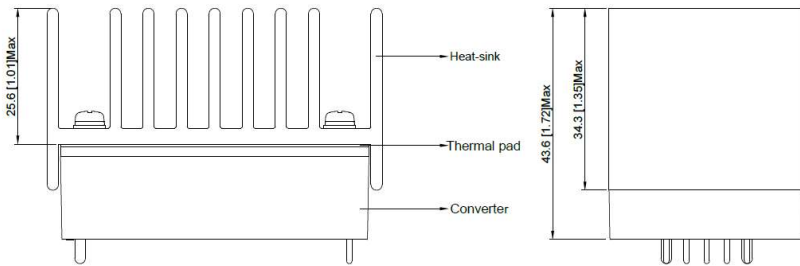
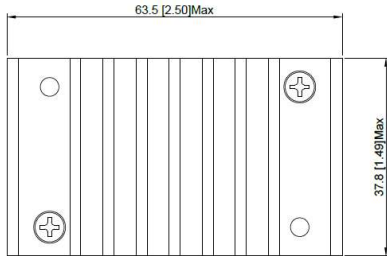

- Note:
1. All dimensions in mm (inches)
  2. Tolerance: X.X ± 0.75 (X.XX ± 0.03)  
X.XX ± 0.25 (X.XXX ± 0.01)
  3. Pin diameter 1.0 ± 0.05 (0.04 ± 0.002)

## Physical Characteristics

Heatsink Size	63.5x37.8x25.6 mm (2.5x1.49x1.01 inches)
Material	Aluminum
Finish	Black Anodized Coating
Weight	63g

## ENVIRONMENTAL SPECIFICATIONS

### EMC Immunity

ERM 150W Series power supply is designed to meet the following EMC immunity specifications:

Table 4. EMC Specifications:			
Parameter	Standards & Level		Performance
General	Compliance with EN50121-3-2 Railway Applications		
EMI	Conduction	EN 55032/11 with an external filter <sup>1</sup>	Class A
	Radiation		
EMS	EN 55024, EN 55035		
	ESD	EN61000-4-2 Air $\pm 8$ kV, Contact $\pm 6$ kV	Criteria A
	Radiated immunity	EN61000-4-3 10V/m	Criteria A
	Fast transient <sup>2</sup>	EN61000-4-4 $\pm 2$ KV	Criteria A
	Surge <sup>2</sup>	EN61000-4-5 $\pm 1$ KV	Criteria A
	Conducted immunity	EN61000-4-6 10Vrms	Criteria A
	PFMF	EN61000-4-8 3A/M	Criteria A

Note1 - Refer to page 25-30.

Note2 - To meet EN 61000-4-4 & EN 61000-4-5 with an external filter requested.

## ENVIRONMENTAL SPECIFICATIONS

### Safety Certifications

The ERM150 power supply is intended for inclusion in other equipment and the installer must ensure that it is in compliance with all the requirements of the end application. This product is only for inclusion by professional installers within other equipment and must not be operated as a stand alone product.

Table 5. Safety Certifications for ERM150 series power supply system		
Standard	Agency	Description
UL 62368-1	UL+CUL	US and Canada Requirements
EN 62368-1	TUV	European Requirements
IEC 62368-1	CB	International Electrotechnical Commission
EN 50155	TUV	Railway standard
IEC 60571	CB	Railway standard
CE Mark		European Requirements
UKCA Mark		UK Requirements

## POWER AND CONTROL SIGNAL DESCRIPTIONS

### Power and Signal Pins

These pins provide power and signal interface to the ERM150 series module.

Pin 1	- Vin (+)	- Input Voltage Positive
Pin 2	- Remote On/Off	- ON / OFF Control
Pin 3	- Vin (-)	- Input Voltage Return
Pin 4	- Vout (-)	- Output Voltage Return
Pin 5	- Sense (-)	- Remote Sense Return
Pin 6	- TRIM	- Output Voltage Trim
Pin 7	- Sense (+)	- Remote Sense Positive
Pin 8	- Vout (+)	- Output Voltage Positive

### Vin (+), Vin (-) – (Pins 1, 3)

These pins are the input voltage positive and input voltage return pins of the module.

### Remote On/Off – (Pin 2)

Remote On/Off pin allows the user to turn ON and OFF the output of the ERM150 series modules.

Parameter	Conditions	Min.	Typ.	Max.	Unit
Converter On	3.5V to 12V or Open Circuit				
Converter Off	0V to 1.2V or Short Circuit				
Control Input Current (on)	Vctrl = 5.0V	-	-	0.5	mA
Control Input Current (off)	Vctrl = 0V	-	-	-0.5	mA
Control Common	Referenced to Negative Input				
Standby Input Current	Nominal Vin	-	3	-	mA

### Vout (+), Vout (-) – (Pins 8, 4)

These pins are the output voltage positive and output voltage return pins of the module.

### Sense (+), Sense (-) – (Pins 7, 5)

The ERM150 is equipped with a remote sensing capability that will compensate for voltage drop between the output pins of the module and the sensed voltage point (load). This feature is implemented by connecting the Sense (+) (pin 7) and the Sense (-) (pin 5) to the positive and return rails of the output, respectively, at a location that is near to the load. Care should be taken in the routing of the sense lines as any noise sources or additional filtering components introduced into the output voltage rail may affect the stability of the power supply. The ERM150 series will operate appropriately without the sense lines connected; however it is recommended that the sense lines be connected directly to the output pins if remote sensing is not required.

## POWER AND CONTROL SIGNAL DESCRIPTIONS

### Trim – (Pin 6)

Output can be externally trimmed by using the method shown below. The trim up/down range is  $\pm 10\%$  minimum of the nominal output voltage.

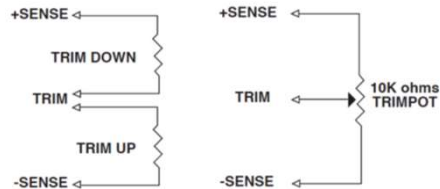

ERM30A100(N)-(HS) Trim Table:

Trim down	1	2	3	4	5	6	7	8	9	10	%
Vout=	Vox0.99	Vox0.98	Vox0.97	Vox0.96	Vox0.95	Vox0.94	Vox0.93	Vox0.92	Vox0.91	Vox0.90	Vdc
Rd=	138.88	62.41	36.92	24.18	16.53	11.44	7.79	5.06	2.94	1.24	KOhm
Trim up	1	2	3	4	5	6	7	8	9	10	%
Vout=	Vox1.01	Vox1.02	Vox1.03	Vox1.04	Vox1.05	Vox1.06	Vox1.07	Vox1.08	Vox1.09	Vox1.10	Vdc
Ru=	106.87	47.76	28.06	18.21	12.30	8.36	5.55	3.44	1.79	0.48	KOhm

ERM12B100(N)-(HS) Trim Table:

Trim down	1	2	3	4	5	6	7	8	9	10	%
Vout=	Vox0.99	Vox0.98	Vox0.97	Vox0.96	Vox0.95	Vox0.94	Vox0.93	Vox0.92	Vox0.91	Vox0.90	Vdc
Rd=	413.55	184.55	108.22	70.05	47.15	31.88	20.98	12.80	6.44	1.35	KOhm
Trim up	1	2	3	4	5	6	7	8	9	10	%
Vout=	Vox1.01	Vox1.02	Vox1.03	Vox1.04	Vox1.05	Vox1.06	Vox1.07	Vox1.08	Vox1.09	Vox1.10	Vdc
Ru=	351.00	157.50	93.00	60.75	41.40	28.50	19.29	12.37	7.00	2.70	KOhm

ERM10C100(N)-(HS) Trim Table:

Trim down	1	2	3	4	5	6	7	8	9	10	%
Vout=	Vox0.99	Vox0.98	Vox0.97	Vox0.96	Vox0.95	Vox0.94	Vox0.93	Vox0.92	Vox0.91	Vox0.90	Vdc
Rd=	530.73	238.61	141.24	92.56	63.35	43.87	29.96	19.53	11.41	4.92	KOhm
Trim up	1	2	3	4	5	6	7	8	9	10	%
Vout=	Vox1.01	Vox1.02	Vox1.03	Vox1.04	Vox1.05	Vox1.06	Vox1.07	Vox1.08	Vox1.09	Vox1.10	Vdc
Ru=	422.77	189.89	112.26	73.44	50.15	34.63	23.54	15.22	8.75	3.58	KOhm

## POWER AND CONTROL SIGNAL DESCRIPTIONS

ERM6H100(N)-(HS) Trim Table:

Trim down	1	2	3	4	5	6	7	8	9	10	%
Vout=	Vox0.99	Vox0.98	Vox0.97	Vox0.96	Vox0.95	Vox0.94	Vox0.93	Vox0.92	Vox0.91	Vox0.90	Vdc
Rd=	598.66	267.78	157.49	102.34	69.25	47.19	31.44	19.62	10.43	3.08	KOhm
Trim up	1	2	3	4	5	6	7	8	9	10	%
Vout=	Vox1.01	Vox1.02	Vox1.03	Vox1.04	Vox1.05	Vox1.06	Vox1.07	Vox1.08	Vox1.09	Vox1.10	Vdc
Ru=	487.14	218.02	128.31	83.46	56.55	38.61	25.79	16.18	8.70	2.72	KOhm

ERM02U100(N)-(HS) Trim Table:

Trim down	1	2	3	4	5	6	7	8	9	10	%
Vout=	Vox0.99	Vox0.98	Vox0.97	Vox0.96	Vox0.95	Vox0.94	Vox0.93	Vox0.92	Vox0.91	Vox0.90	Vdc
Rd=	1882.57	877.94	543.06	375.62	275.15	208.18	160.34	124.46	96.55	74.23	KOhm
Trim down	11	12	13	14	15						%
Vout=	Vox0.89	Vox0.88	Vox0.87	Vox0.86	Vox0.85						Vdc
Ru=	55.96	40.74	27.86	16.82	7.25						KOhm
Trim up	1	2	3	4	5						%
Vout=	Vox1.01	Vox1.02	Vox1.03	Vox1.04	Vox1.05						Vdc
Ru=	560.73	230.36	120.24	65.18	32.15						KOhm

## APPLICATION NOTES

### Output Ripple Reduction

A good quality low ESR capacitor placed as close as practicable across the load will give the best ripple and noise performance. To reduce output ripple, it is recommended to use 4.7 $\mu$ F capacitors at the output.

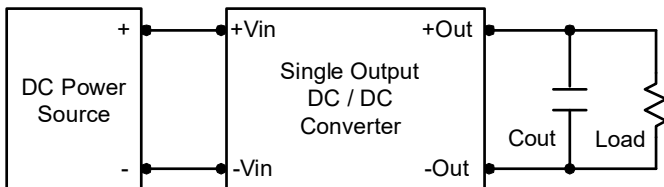

### Peak-to-Peak Output Noise Measurement Test

Use a 22 $\mu$ F polymer capacitor for 5V, 12V, 15V output models and a 33 $\mu$ F polymer capacitor for 24V output model and a 1 $\mu$ F ceramic capacitor for 54V output model. Scope measurement should be made by using a BNC socket, measurement bandwidth is 0-20MHz. Position the load between 50 mm and 75 mm from the DC/DC Converter.

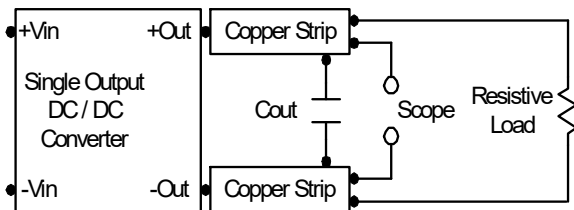

### Maximum Capacitive Load

The ERM150 series has limitation of maximum connected capacitance at the output. The power module may be operated in current limiting mode during start-up, affecting the ramp-up and the startup time. The maximum capacitance can be found in table 3.

## APPLICATION NOTES

### Thermal Considerations

Many conditions affect the thermal performance of the power module, such as orientation, airflow over the module and board spacing. To avoid exceeding the maximum temperature rating of the components inside the power module, the case temperature must be kept below 105 °C. The derating curves are determined from measurements obtained in a test setup.

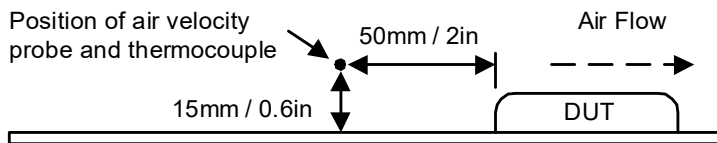

### Output Voltage and Efficiency Measurement Test

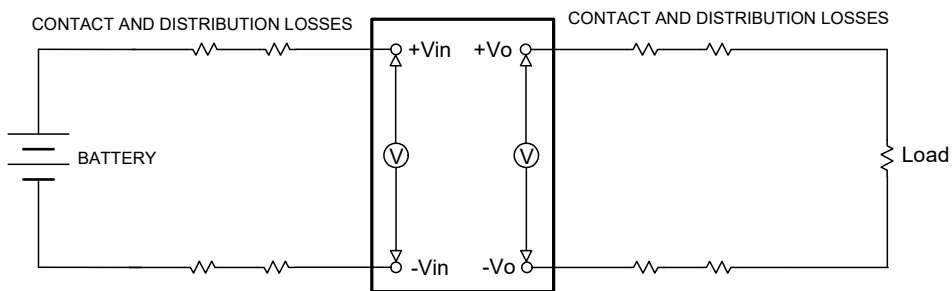

$$\text{Efficiency} = \left( \frac{V_{out} \times I_{out}}{V_{in} \times I_{in}} \right) \times 100\%$$



# APPLICATION NOTES

## EMI Emissions

Recommended circuit to comply EN55032 Class A Limits

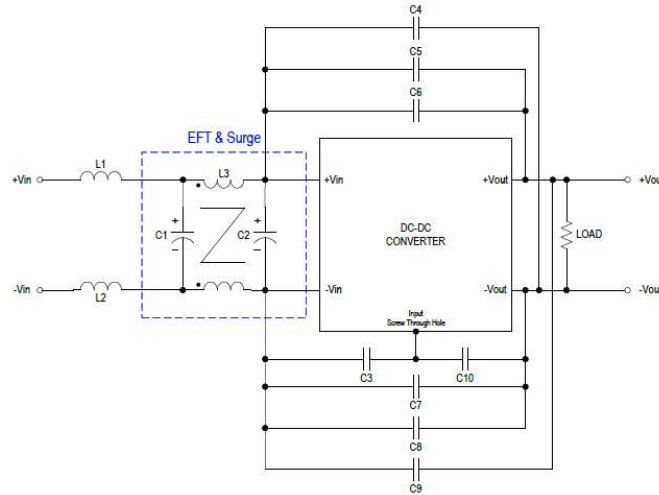

Recommended PCB Layout with Input Filter

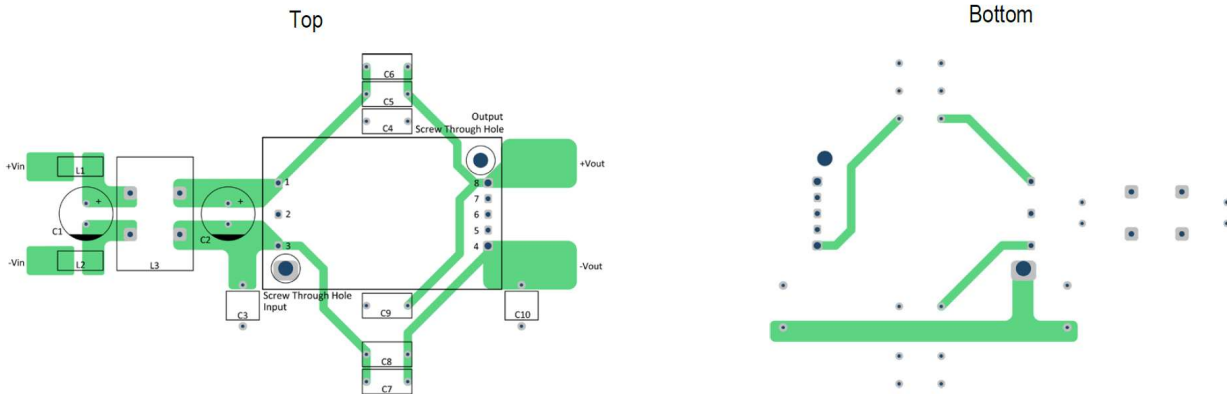

To comply with EN55032 Class A following components are needed:

Model	Component	Value
ERM30A100	L1,L2	425Ω(25MHz)/5A
	C1	150uF/200V
	L3	7mH/7A
	C2	82uF/200V
	C3,C10	220pF/Y1 Cap
	C4,C9	2200pF/Y1 Cap
	C5,C8	4700pF/Y1 Cap
	C6,C7	-

# APPLICATION NOTES

Recommended circuit to comply EN55032 Class A Limits

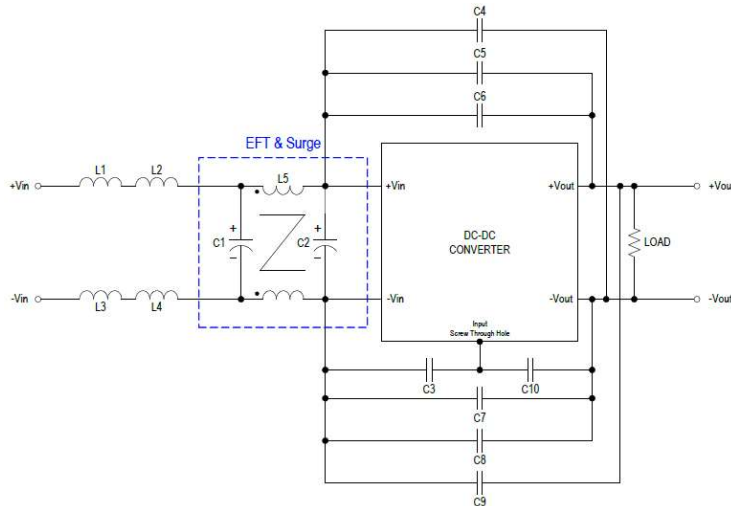

Recommended PCB Layout with Input Filter

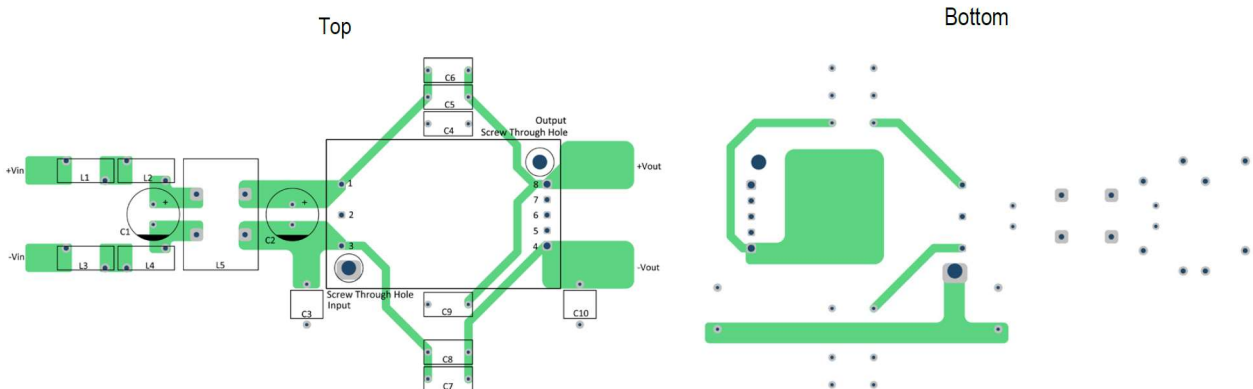

To: comply with EN55032 Class A following components are needed:

Model	Component	Value
ERM12B100	L1, L2, L3, L4	2uH/5A
	C1, C2	150uF/200V
	L5	9mH/5A
	C3, C10	470pF/Y1 Cap
	C5, C8	4700pF/Y1 Cap
	C4, C6, C7, C9	-

# APPLICATION NOTES

Model	Component	Value
ERM10C100	L1, L2, L3, L4	2uH/5A
	C1, C2	150uF/200V
	L5	9mH/5A
	C3, C10	470pF/Y1 Cap
	C4, C9	2200pF/Y1 Cap
	C5, C8	4700pF/Y1 Cap
	C6, C7	-

Recommended circuit to comply EN55032 Class A Limits

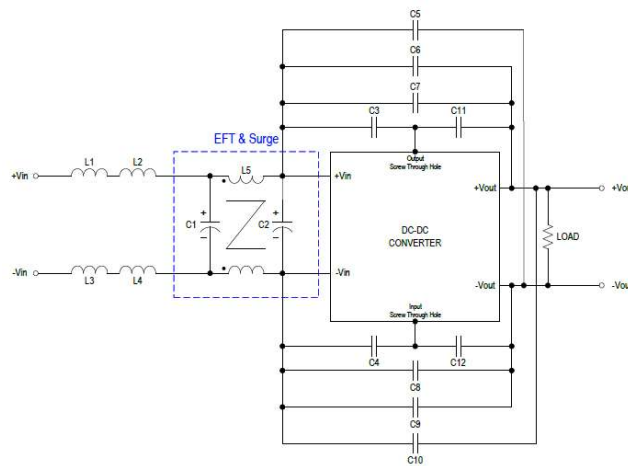

Recommended PCB Layout with Input Filter

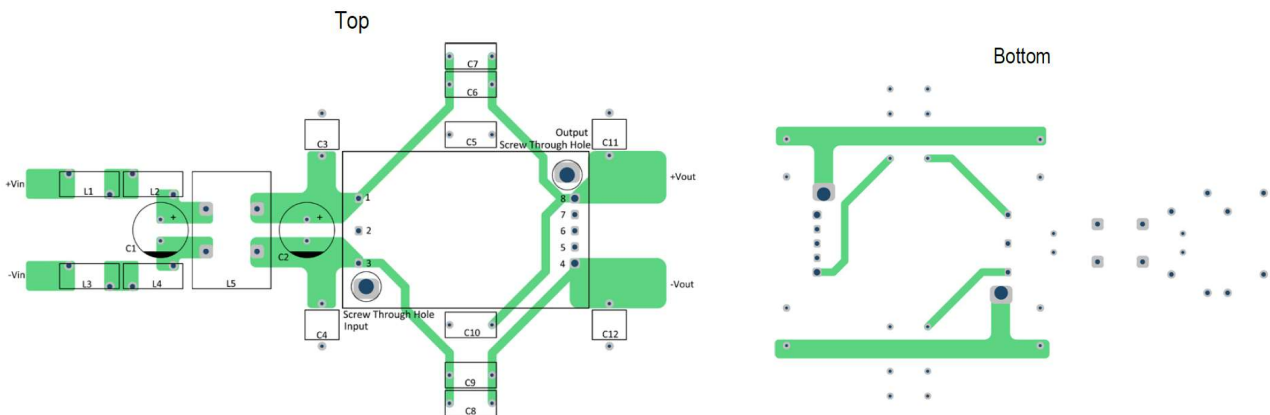

## APPLICATION NOTES

To: comply with EN55032 Class A following components are needed:

Model	Component	Value
ERM6H100	L1, L2, L3, L4	2uH/5A
	C1, C2	150uF/200V
	L5	3.3mH/4A
	C3, C4, C11, C12	220pF/Y1 Cap
	C5	1000pF/Y1 Cap
	C6, C9	4700pF/Y1 Cap
	C7, C8, C10	-

Recommended circuit to comply EN55032 Class A Limits

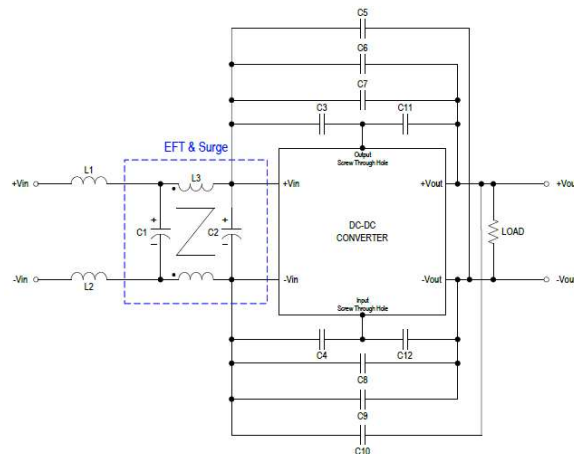

Recommended PCB Layout with Input Filter

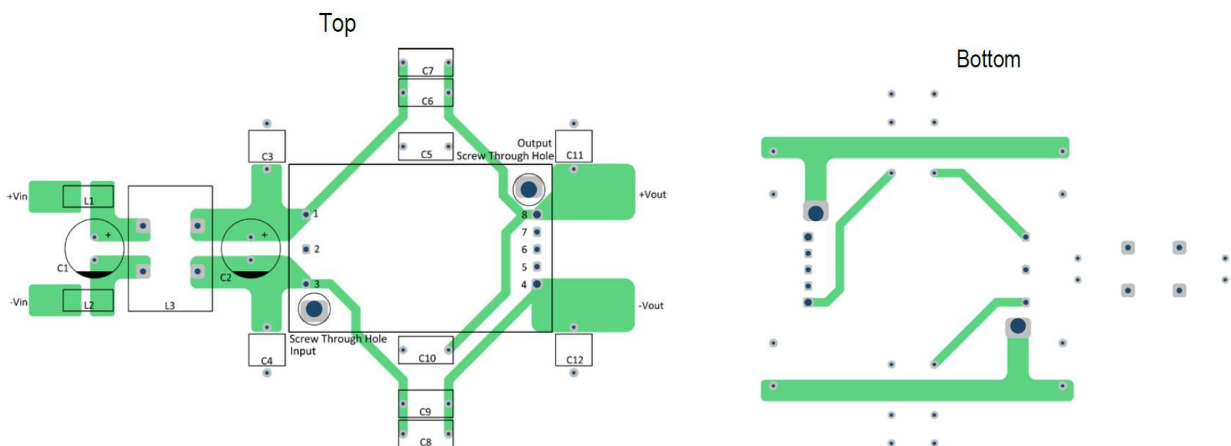

## APPLICATION NOTES

To comply with EN55032 Class A following components are needed:

Model	Component	Value
ERM02U100	L1, L2	425Ω(25MHz)/5A
	C1	150uF/200V
	C2	82uF/200V
	L3	7mH/7A
	C3, C4, C11, C12	220pF/Y1 Cap.
	C5, C7, C8	2200pF/Y1 Cap.
	C6, C9	4700pF/Y1 Cap.
	C10	-

## APPLICATION NOTES

Recommended circuit to comply EN55032 Class B Limits

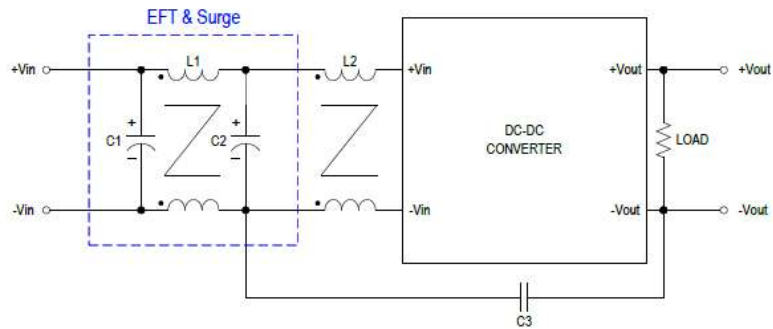

Recommended PCB Layout with Input Filter

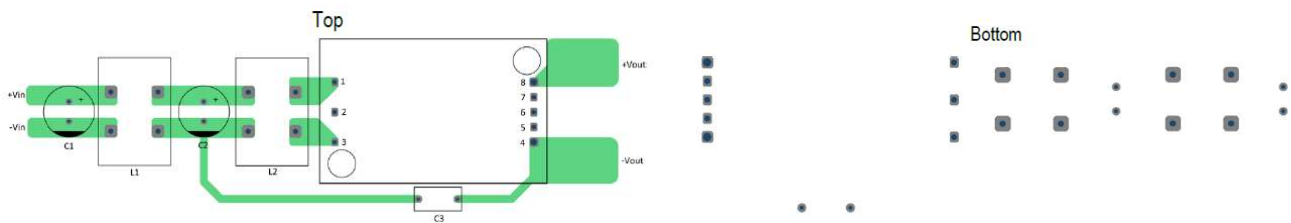

To comply with EN55032 Class B following components are needed:

Model	Component	Value
ERM150 Series	C1	390uF/200V
	L1	7mH/7A
	C2	150uF/200V
	L2	2.2mH/6A
	C3	4700pF/Y1 Cap.

## APPLICATION NOTES

### Remote ON/OFF Control

Positive logic remote on/off turns the module on during a logic high voltage on the remote on/off pin, and off during a logic low. To turn the power module on and off, the user must supply a switch to control the voltage between the on/off terminal and the -Vin terminal. The switch can be an open collector or equivalent. A logic low is 0V to 1.2V. A logic high is 3.5V to 12V. The maximum sink current at the on/off terminal (Pin 3) during a logic low is -100uA. The ON/OFF input signal (Von/off) that referenced to GND. If not using the remote on/off feature, please open circuit between on/off pin and -Vin pin to turn the module on. Remote ON/OFF implementation is below.

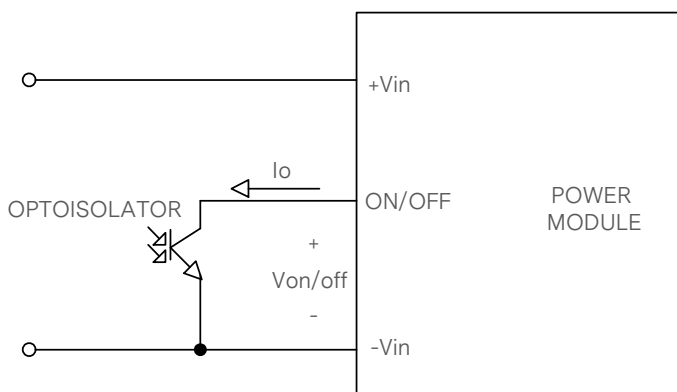

Isolate-Closure Remote ON/OFF

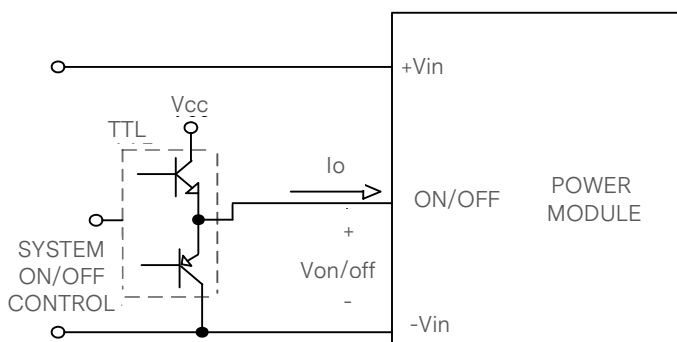

Level Control Using TTL Output

# APPLICATION NOTES

## Packaging Information

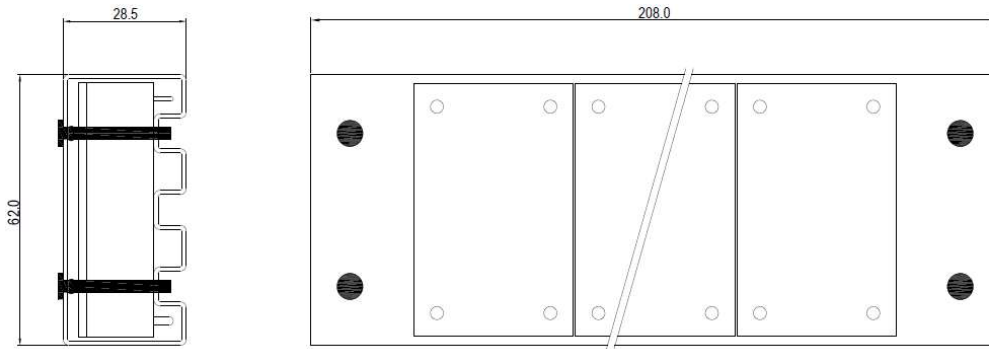

Unit: mm  
5 PCS per TUBE (Without heatsink)

## Soldering and Reflow Considerations

Lead free wave solder profile for ERM150 Series

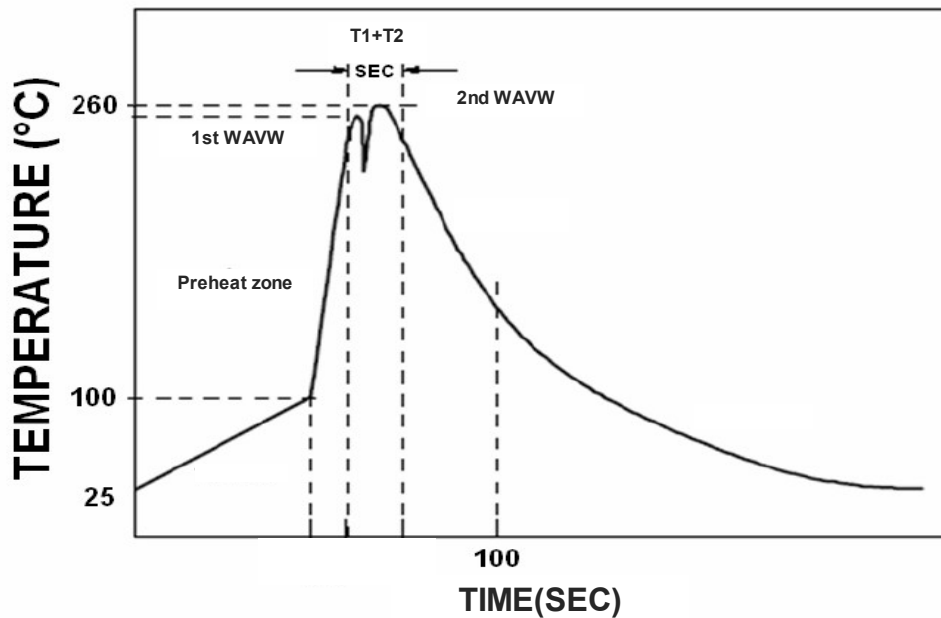



**RECORD OF REVISION AND CHANGES**

Issue	Date	Description	Originators
1.0	08.24.2022	First Issue	J.Zhang
1.1	02.23.2024	Add note on case and base material	J.Zhang
1.2	05.08.2024	Update the part number “ERM06H100” to “ERM6H100” since the labels, artwork and safety approvals were done with the ERM6H100 part number	K. Wang



For international contact information,  
visit [advancedenergy.com](http://advancedenergy.com).

[powersales@aei.com](mailto:powersales@aei.com) (Sales Support)  
[productsupport.ep@aei.com](mailto:productsupport.ep@aei.com) (Technical Support)  
+1 888 412 7832

## ABOUT ADVANCED ENERGY

Advanced Energy (AE) has devoted more than three decades to perfecting power for its global customers. AE designs and manufactures highly engineered, precision power conversion, measurement and control solutions for mission-critical applications and processes.

Our products enable customer innovation in complex applications for a wide range of industries including semiconductor equipment, industrial, manufacturing, telecommunications, data center computing, and medical. With deep applications know-how and responsive service and support across the globe, we build collaborative partnerships to meet rapid technological developments, propel growth for our customers, and innovate the future of power.

## PRECISION | POWER | PERFORMANCE

---

Specifications are subject to change without notice. Not responsible for errors or omissions. ©2022 Advanced Energy Industries, Inc. All rights reserved. Advanced Energy®, and AE® are U.S. trademarks of Advanced Energy Industries, Inc.