

ARTESYN

AVQ100-36S3V3 SERIES

82.5 Watts Quarter-brick Converter

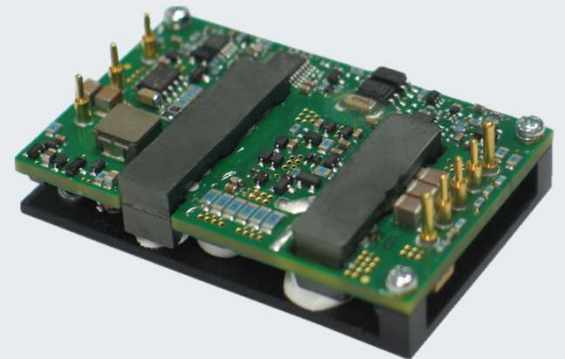

PRODUCT DESCRIPTION

Advanced Energy's Artesyn AVQ100-36S3V3 is a single output DC/DC converter with standard quarter-brick outline and pin configuration. It delivers up to 25A output current with 3.3V output voltage. Above 90% ultra-high efficiency and excellent thermal performance makes it an ideal choice to used in telecom and datacom applications and can operate under an ambient temperature range of -40 °C to +85 °C.

AT A GLANCE

Total Power

82.5 Watts

Input Voltage

18 to 60 Vdc

of Outputs

Single

SPECIAL FEATURES

- Delivering up to 25A output
- Ultra-high efficiency: 90% (typ., full load,48V).92% (typ.,half load,24V)
- Wide input range: 18V to 60V
- Excellent thermal performance
- No minimum load requirement
- Start-up and shut-down monotonically into any normal and pre-biased loads, internal pre-bias function circuit prevents back negative current drawn from external load
- RoHS 3.0
- Remote control function
- Remote output sense
- Trim function:80% to 110%
- Input under voltage lockout
- Output over current protection
- Output over voltage protection
- Over temperature protection
- Industry standard quarter-brick pin-out outline
- Open frame or baseplate optional
- Pin length optional

SAFETY

- TUV EN 62368-1
- CE EN 60950-1

TYPICAL APPLICATIONS

- Telecom
- Datacom



MODEL NUMBERS

Standard	Output Voltage	Structure	Remote ON/OFF logic	ROHS
AVQ100-36S3V3-6L	3.3Vdc	Open frame	Negative	RoHS 3.0
AVQ100-36S3V3B-6L	3.3Vdc	Baseplate	Negative	RoHS 3.0

Order Information

AVQ100	-	36	S	3V3	P	B	-	6	L
①		②	③	④	⑤	⑥		⑦	⑧

①	Model series	AVQ100: high efficiency quarter-brick series
②	Input voltage	36: 18V ~ 60V input range, rated input voltage 48V
③	Output number	S: single output
④	Rated output voltage	3V3: 3.3V output
⑤	Remote ON/OFF logic	Default: negative logic; P: positive logic
⑥	Baseplate	B: baseplate; default: open frame
⑦	Pin length	6: 3.8mm
⑧	RoHS status	L: RoHS 3.0

Options

None

ELECTRICAL SPECIFICATIONS

Absolute Maximum Ratings

Stress in excess of those listed in the “Absolute Maximum Ratings” may cause permanent damage to the power supply. These are stress ratings only and functional operation of the unit is not implied at these or any other conditions above those given in the operational sections of this TRN. Exposure to any absolute maximum rated condition for extended periods may adversely affect the power supply’s reliability.

Table 1. Absolute Maximum Ratings						
Parameter	Model	Symbol	Min	Typ	Max	Unit
Input Voltage	Operating -Continuous	All	-	-	60	Vdc
	Non-operating -100mS	All	-	-	80	Vdc
Maximum Output Power	All	$P_{O,max}$	-	-	82.5	W
Isolation Voltage ¹	Input to Output	Open-frame module	1500	-	-	Vdc
	Input to Baseplate	Baseplate module	1500	-	-	Vdc
	Output to Baseplate	Baseplate module	1500	-	-	Vdc
Ambient Operating Temperature	All	T_A	-40	-	+85	°C
Storage Temperature	All	T_{STG}	-55	-	+125	°C
Voltage at Remote ON/OFF Pin	All		-0.7	-	12	Vdc
Humidity (non-condensing)	Operating	All	-	-	95	%
	Non-operating		-	-	95	

Note 1 - 1mA for 60s, slew rate of 1500V/10s

ELECTRICAL SPECIFICATIONS

Input Specifications

Table 2. Input Specifications						
Parameter	Conditions ¹	Symbol	Min	Typ	Max	Unit
Operating Input Voltage, DC	All	$V_{IN,DC}$	18	48	60	Vdc
Turn-on Voltage Threshold	$I_O = I_{O,max}$	$V_{IN,ON}$	16.2	16.7	17.2	Vdc
Turn-off Voltage Threshold	$I_O = I_{O,max}$	$V_{IN,OFF}$	14.6	15.1	15.6	Vdc
Lockout Voltage Hysteresis	$I_O = I_{O,max}$		1.1	1.6	2.1	V
Maximum Input Current ($I_O = I_{O,max}$)	$V_{IN,DC} = 18Vdc$ $I_O = I_{O,max}$	$I_{IN,max}$	-	-	6	A
No-load Input Current	$I_O = 0A$	I_{IN}	-	-	0.1	A
Standby Input Current	Remote OFF	I_{IN}	-	0.005	0.01	A
Inrush Current Transient Rating	Power ON		-	-	0.5	A ² s
Recommended Input Fuse	Fast blow external fuse recommended		-	-	15	A
Input filter component values (C\L)	Internal values		-	7.6\2.2	-	uF\uH
Recommended External Input Capacitance	Low ESR capacitor recommended	C_{IN}	-	100	-	uF
Input Reflected Ripple Current	Through 12uH inductor		-	10	20	mA
Operating Efficiency	$T_A = 25\text{ }^\circ\text{C}$ $V_{in}=24Vdc$ $I_O = I_{O,max}$ $I_O = 50\%I_{O,max}$	η	-	90	-	%
	$T_A = 25\text{ }^\circ\text{C}$ $V_{in}=48Vdc$ $I_O = I_{O,max}$ $I_O = 50\%I_{O,max}$	η	-	90.5	-	%

Note 1 - $T_A = 25\text{ }^\circ\text{C}$, airflow rate = 400 LFM, $V_{in} = 48Vdc$, nominal V_{out} unless otherwise noted.

ELECTRICAL SPECIFICATIONS

Output Specifications

Table 3. Output Specifications							
Parameter	Conditions ¹	Symbol	Min	Typ	Max	Unit	
Factory Set Voltage	$V_{IN,DC} = 48Vdc$ $I_O = I_{O,max}$	V_O	3.267	3.300	3.333	Vdc	
Output Voltage Line Regulation	All	$\%V_O$	-	0.05	-0.15	%	
Output Voltage Load Regulation	All	$\%V_O$	-	0.05	0.15	%	
Output Voltage Temperature Regulation	All	$\%V_O$	-	0.02	-	$\%/^{\circ}C$	
Total Output Voltage Range (Over sample, line, load, temperature & life)	All	V_O	3.25	3.30	3.35	V	
Output Voltage Trim Range	All	V_O	2.64	-	3.63	V	
Output Ripple, pk-pk	20MHz bandwidth	V_O	-	40	70	mV _{PK-PK}	
Output Current	All	I_O	0	-	25	A	
Output DC Current-limit Inception ²	All	I_O	27.5	-	35	A	
Reverse Current-limit While Enabled ³	All		0.5	1.0	2.0	A	
Reverse Current-limit While Disabled ⁴	All		0	10	50	mA	
Vout Pre-bias Level	All	$\%V_O$	-	-	90	%	
V_O Load Capacitance ⁵	All	C_O	470	470	10000	μF	
V_O Dynamic Response	Peak Deviation Settling Time	50% ~75%~50% slew rate = 0.1A/us	$\pm V_O$ T_s	- -	150 100	- -	mV μSec
		50% ~75%~50% slew rate = 1A/us	$\pm V_O$ T_s	- -	180 200	- -	mV μSec
Turn-on Transient	Rise Time	$I_O = I_{O,max}$	T_{rise}	-	10	30	mS
	Turn-on Delay Time	$I_O = I_{O,max}$	$T_{turn-on}$	-	5	10	mS
	Output Voltage Overshoot	$I_O = 0$	$\%V_O$	-	0	-	%
Switching Frequency	All	f_{sw}	295	300	305	KHz	

Note 1 - $T_a = 25^{\circ}C$, airflow rate = 400 LFM, $V_{in} = 48Vdc$, nominal V_{out} unless otherwise noted.

Note 2 - Hiccup: auto-restart when over-current condition is removed.

Note 3 - Negative current drawn from output

Note 4 - Negative current drawn from output

Note 5 - High frequency and low ESR is recommended.

ELECTRICAL SPECIFICATIONS

Output Specifications

Table 3. Output Specifications Con't							
Parameter		Conditions ¹	Symbol	Min	Typ	Max	Unit
Remote ON/OFF control (positive logic)	Off-state Voltage	All		-0.7	-	1.2	V
	On-state Voltage	All		3.5	-	12	V
Remote ON/OFF control (negative logic)	Off-state Voltage	All		3.5	-	12	V
	On-state Voltage	All		-0.7	-	1.2	V
Output Over-voltage Protection ⁶		All	V_O	3.8	4.2	5.0	mV
Output Over-temperature Protection ⁷		Open-frame	T	-	118	-	°C
		Baseplate	T	-	100	-	°C
Over-temperature Hysteresis		All	T	-	5	-	°C
Output Voltage Remote Sense Range		All	$\pm V_O$	-	-	0.5	V
MTBF		Telcordia SR-332-2006; 80% load, 300LFM, 40 °C Ta		-	2.5	-	10 ⁶ h

Note 6 - Hiccup: auto-restart when over-voltage condition is removed.

Note 7 - Auto recovery.

ELECTRICAL SPECIFICATIONS

AVQ100-36S3V3 Performance Curves

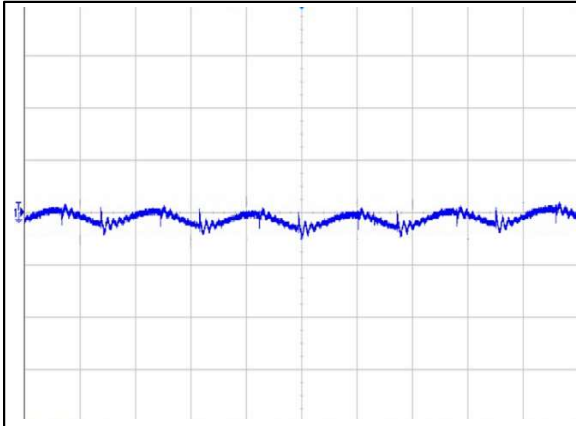

Figure 1: AVQ100-36S3V3 Input Reflected Ripple Current Waveform
Ch 1: Iin (2uS/div, 5mA/div)

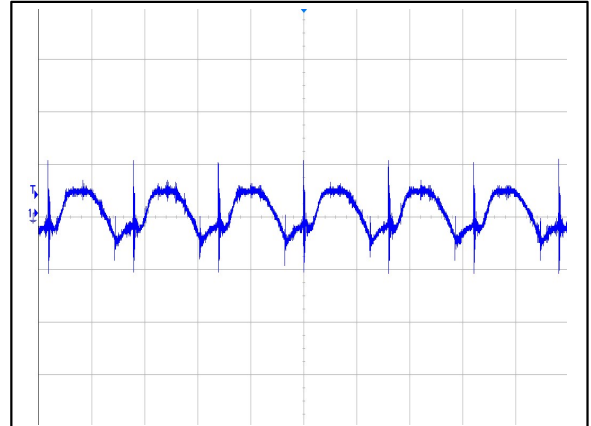

Figure 2: AVQ100-36S3V3 Ripple and Noise Measurement
Ch 1: Vo (2uS/div, 20mV/div)

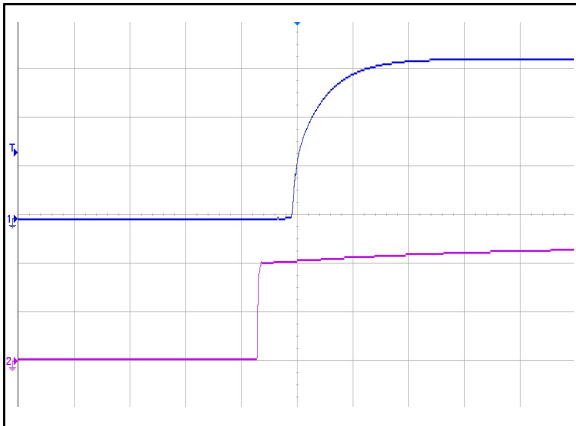

Figure 3: AVQ100-36S3V3 Output Voltage Startup Characteristic (5mS/div)
Ch 1: Vo (1V/div) Ch 2: Vin (20V/div)

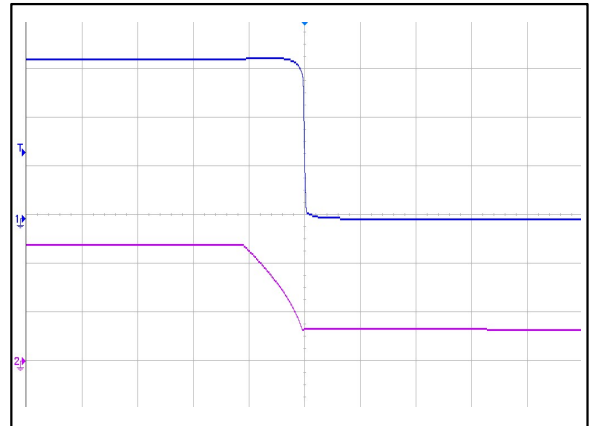

Figure 4: AVQ100-36S3V3 Turn Off Characteristic (2mS/div)
Ch 1: Vo (1V/div) Ch 2: Vin (20V/div)

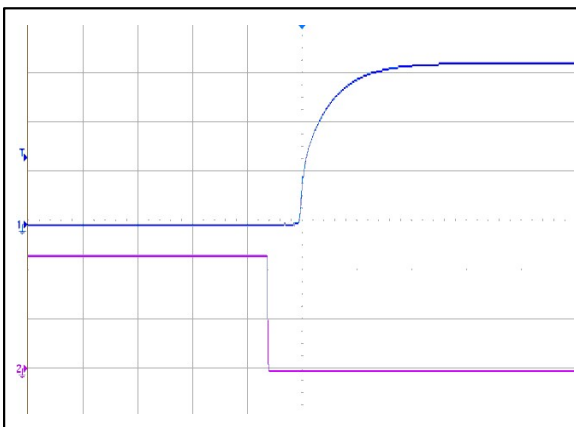

Figure 5: AVQ100-36S3V3 Remote ON Waveform (5mS/div)
Ch 1: Vo (1V/div) Ch 2: Remote ON (2V/div)

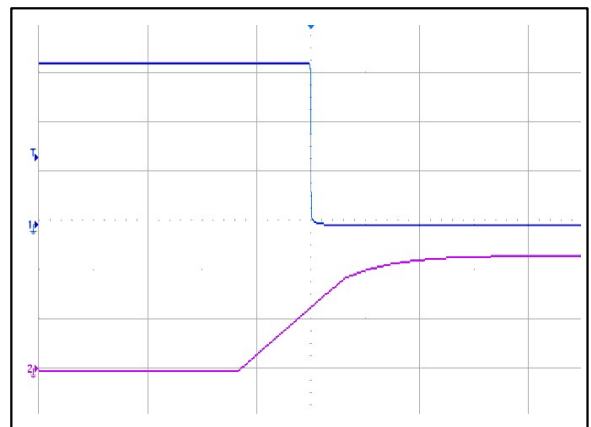

Figure 6: AVQ100-36S3V3 Remote OFF Waveform (5mS/div)
Ch 1: Vo (1V/div) CH 2: Remote OFF (2V/div)

ELECTRICAL SPECIFICATIONS

AVQ100-36S3V3 Performance Curves

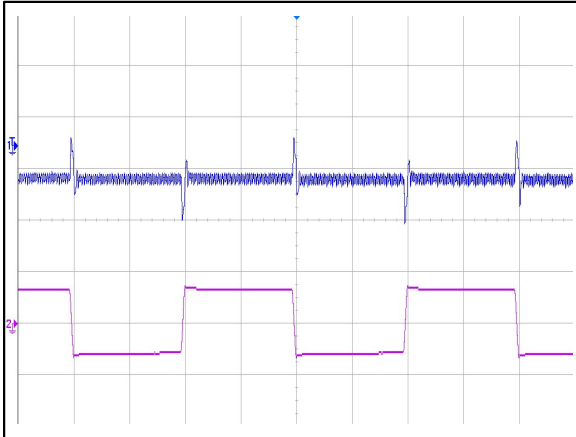

Figure 7: AVQ100-36S3V3 Transient Response (1mS/div)
 50%~75%~50% load change, 0.1A/uS slew rate
 Ch 1: Vo (50mV/div) Ch 2: Io (2A/div)

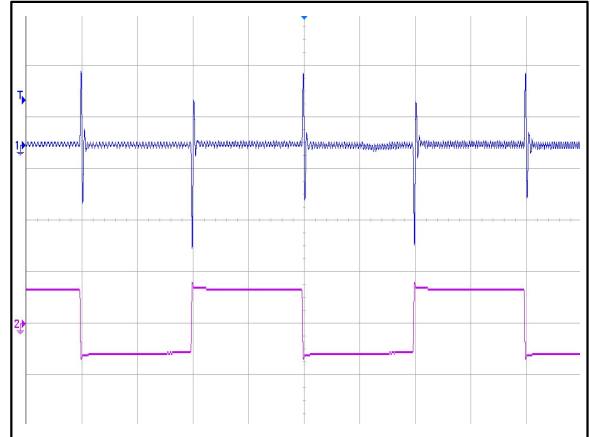

Figure 8: AVQ100-36S3V3 Transient Response (1mS/div)
 50%~75%~50% load change, 1A/uS slew rate
 Ch 1: Vo (100mV/div) Ch 2: Io (2A/div)

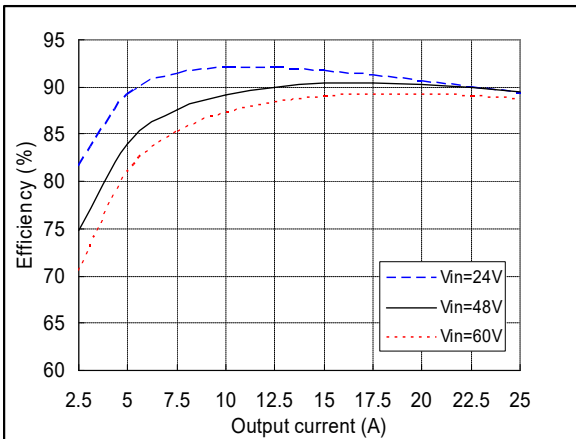
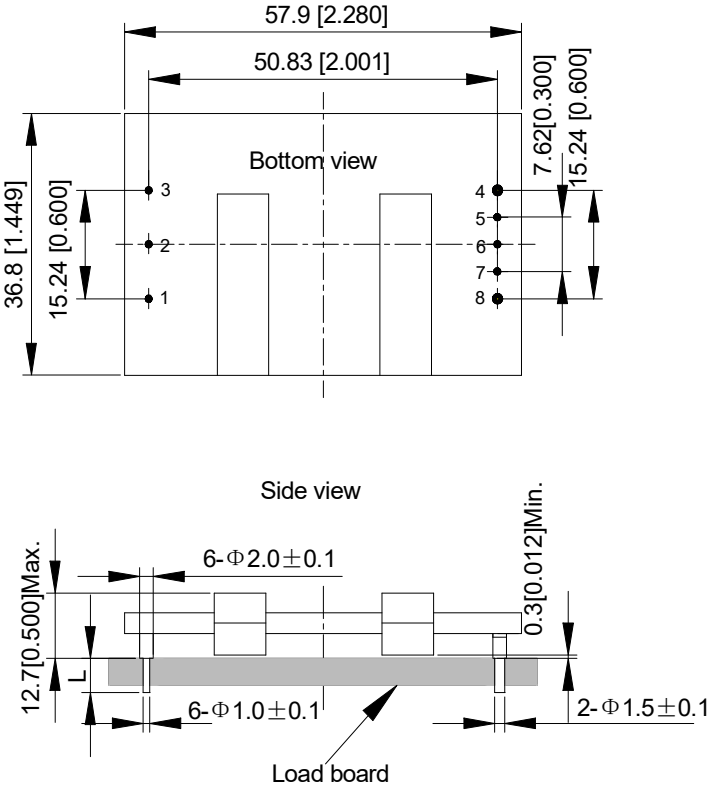

Figure 9: AVQ100-36S3V3 Efficiency Curves @ 25 °C, Vo=3.3V

MECHANICAL SPECIFICATIONS

Mechanical Outlines – Open-frame Module



Unit: mm[inch] Bottom view: pin on upside
 Tolerance: X.Xmm±0.5mm[X.X in.±0.02in.]
 X.XXmm±0.25mm[X.XX in.±0.01in.]

Figure 10 Open-frame product

Note: “6-Ø1.0” means there are 6 pins (Pins 1,2,3,4,5,6,7), the diameter of which is 1mm.
 “2-Ø1.5” means there are 2 pins (Pins 4,8), the diameter of which is 1.5mm.

MECHANICAL SPECIFICATIONS

Mechanical Outlines – Baseplate Module

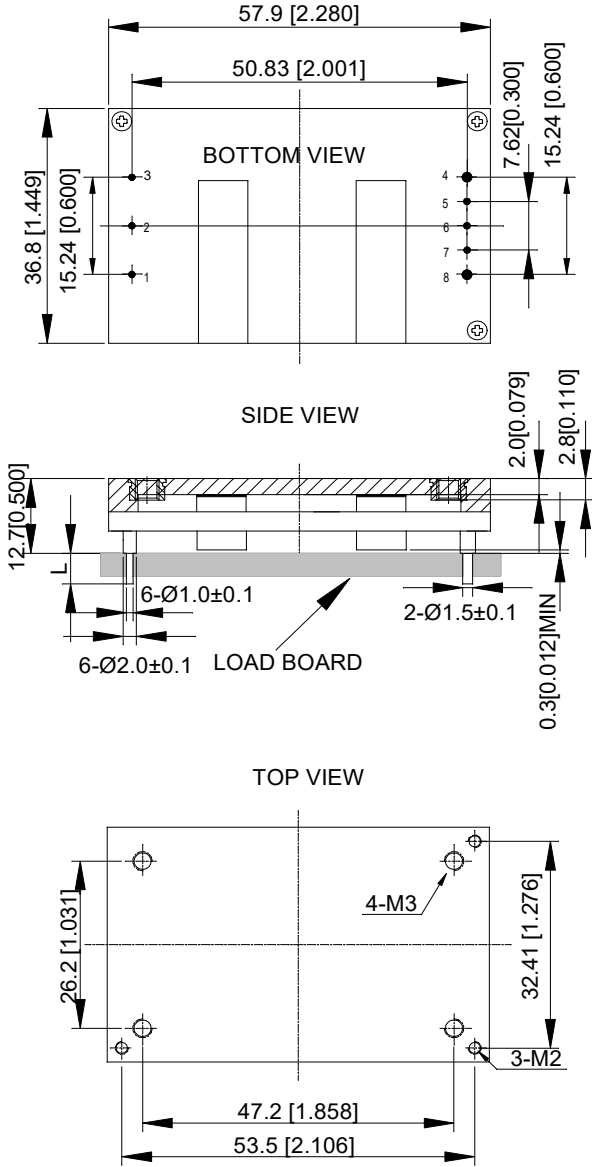

UNIT: mm[inch] BOTTOM VIEW: pin on upside
 TOLERANCE: X.Xmm±0.5mm[X.X in.±0.02in.]
 X.XXmm±0.25mm[X.XX in.±0.01in.]

Figure 11 Baseplate product

Note: Depth penetration into base plate, of M3 screws used at baseplate mounting holes, not to exceed maximum of 3.0mm

MECHANICAL SPECIFICATIONS

Pin length option

Device code suffix	L
-4	4.8mm ± 0.2mm
-6	3.8mm ± 0.2mm
-8	2.8mm ± 0.2mm
None	5.8mm ± 0.2mm

Pin Designations

Pin No	Name	Function
1	Vin+	Positive input voltage
2	Remote ON/OFF	Remote control
3	Vin-	Negative input voltage
4	Vo-	Negative output voltage
5	S-	Negative remote sense
6	Trim	Output voltage trim
7	S+	Positive remote sense
8	Vo+	Positive output voltage

ENVIRONMENTAL SPECIFICATIONS

Environmental Specifications

EMC Immunity

AVQ100-36S3V3 Series power supply is designed to meet the following EMC immunity specifications:

Document	Description	Criteria
EN55022, Class A Limits	Conducted and Radiated EMI Limits	/
IEC/EN 61000-4-2, Level 3	Electromagnetic Compatibility (EMC) - Testing and measurement techniques - Electrostatic discharge immunity test. Enclosure Port	B
IEC/EN 61000-4-4, Level 3	Electromagnetic Compatibility (EMC) - Testing and measurement techniques, Electrical Fast Transient. DC input port.	B
IEC/EN 61000-4-5	Electromagnetic Compatibility (EMC) - Testing and measurement techniques, Immunity to surges - 600V common mode and 600V differential mode for DC ports	B
IEC/EN 61000-4-6, Level 2	Electromagnetic Compatibility (EMC) - Testing and measurement techniques, Continuous Conducted Interference. DC input port	A
EN61000-4-29	Electromagnetic Compatibility (EMC) - Testing and measurement techniques, Voltage Dips and short interruptions and voltage variations. DC input port	B

Criterion A: Normal performance during and after test.

Criterion B: For EFT and surges, low-voltage protection or reset is not allowed. Temporary output voltage fluctuation ceases after disturbances ceases, and from which the EUT recovers its normal performance automatically.

For Dips and ESD, output voltage fluctuation or reset is allowed during the test, but recovers to its normal performance automatically after the disturbance ceases.

Criterion C: Temporary loss of output, the correction of which requires operator intervention.

Criterion D: Loss of output which is not recoverable, owing to damage to hardware.

ENVIRONMENTAL SPECIFICATIONS

EMC Test Configuration

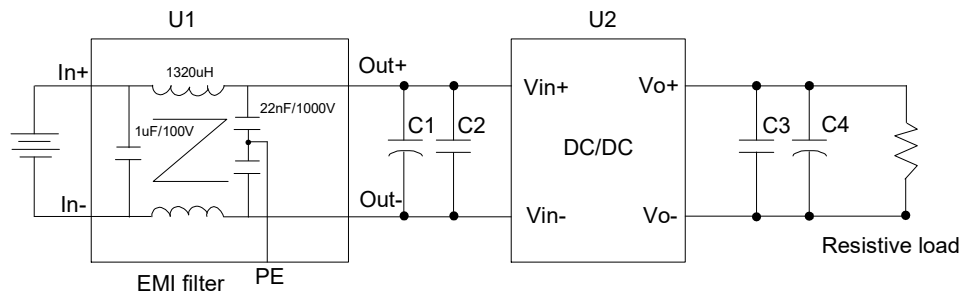

Figure 12 EMC test configuration

U1: 5A input EMC filter module

U2: Module to test, AVQ100-36S3V3

C1 ~ C4: See Figure 22

Baseplate: Be not connected

ENVIRONMENTAL SPECIFICATIONS

Safety Certifications

The AVQ100-36S3V3 Series power supply is intended for inclusion in other equipment and the installer must ensure that it is in compliance with all the requirements of the end application. This product is only for inclusion by professional installers within other equipment and must not be operated as a stand alone product.

Table 4. Safety Certifications for AVQ100-36S3V3 series power supply system

Standard	Agency	Description
EN 62368-1:2014/A11:2017	TUV-SUD	European Requirements
EN 60950-1:2006+A11:2009+A1:2010+A12:2011+A2:2013	CE	CE Marking

ENVIRONMENTAL SPECIFICATIONS

Operating Temperature

The AVQ100-36S3V3 series power supplies will start and operate within stated specifications at an ambient temperature from -40 °C to 85 °C under all load conditions. The storage temperature is -55 °C to 125 °C.

Thermal Considerations – Open-frame Model

The converter is designed to operate in different thermal environments and sufficient cooling must be provided. Proper cooling can be verified by measuring the temperature at the OTP Test Point. The temperature at this point should not exceed the max values in the table 5.

For a typical application, Figure 15 and Figure 16 show the derating of output current vs. ambient air temperature at different air velocity.

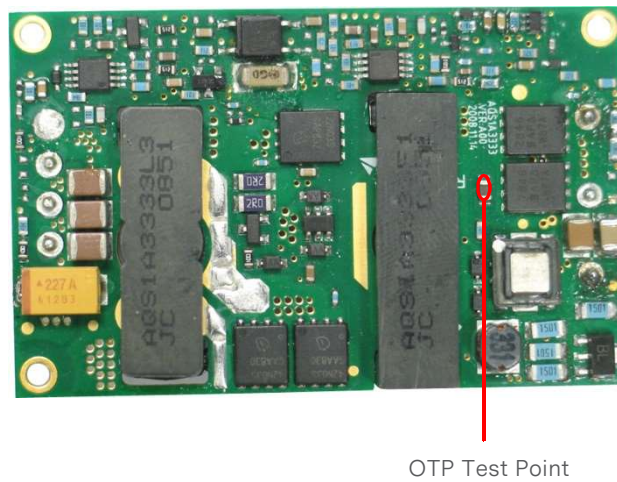

Figure 13 Thermal test points(TOP)

Table 5 Temperature limit of the test points	
Test Point	Temperature limit
OTP Test Point	113 °C

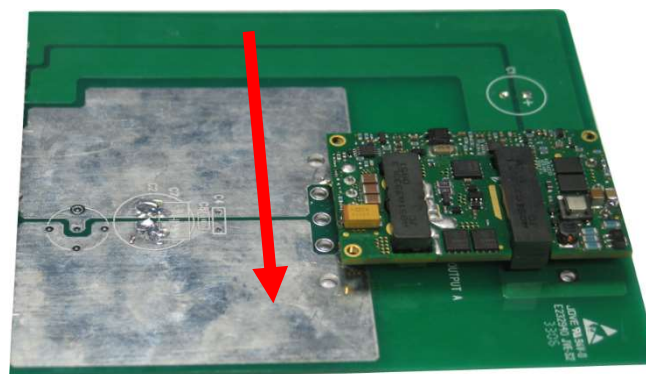

Figure 14 Typical test condition. Forced airflow direction is from Vin- to Vin+

ENVIRONMENTAL SPECIFICATIONS

Thermal Considerations – Open-frame Model Con't

The converter can operate with a smaller heatsink and sufficient airflow. Figure 15 & Figure 16 show the derating output current vs. ambient air temperature at different air velocities with a specified heatsink.

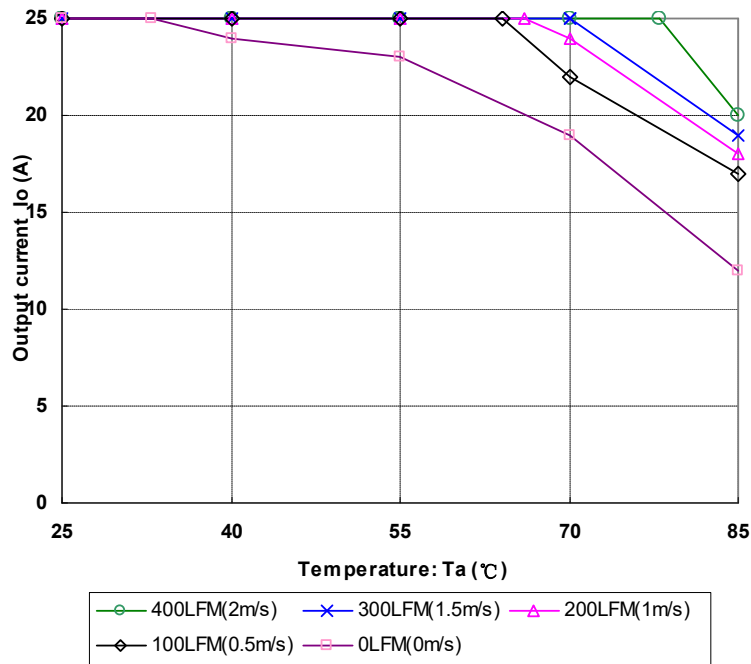

Figure 15 Output power derating, 48V_{in}, air flowing across the converter from V_{in-} to V_{in+}

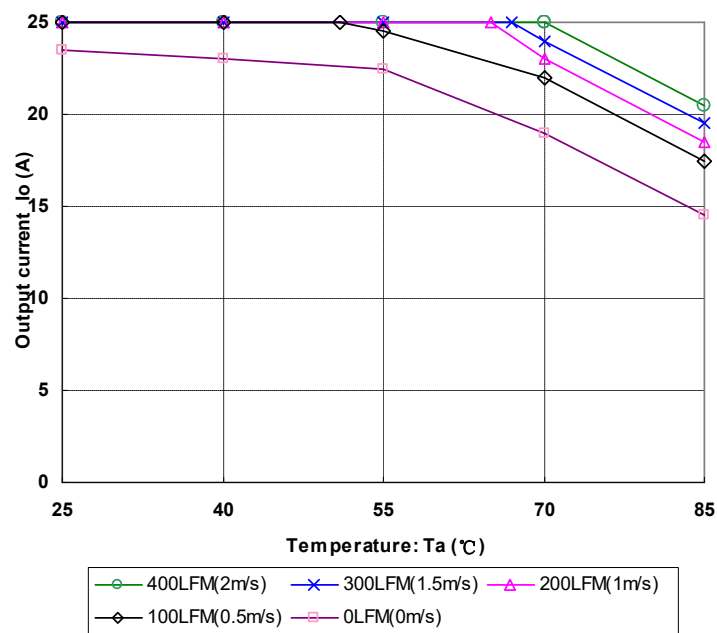

Figure 16 Output power derating, 24V_{in}, air flowing across the converter from V_{in-} to V_{in+}

ENVIRONMENTAL SPECIFICATIONS

Thermal Considerations - Baseplate Model

The converter is designed to operate in different thermal environments and sufficient cooling must be provided.

Proper cooling of the DC/DC converter can be verified by measuring the temperature at the test point(s). The temperature at this/these point(s) should not exceed the max values in the table6.

The converter can operate in an enclosed environment without forced air convection. Cooling of the converter is achieved mainly by conduction from the baseplate to a heatsink. The converter can deliver full output power at 85 °C ambient temperature provided the baseplate temperature is kept below the max values in the table6.



Figure 17 Test point on baseplate

Table 6 Temperature limit of the test points	
Test Point	Temperature limit
OTP Test Point	95 °C

The converter can also operate with a smaller heatsink and sufficient airflow. Figure20 & Figure21 shows the derating output current vs. ambient air temperature at different air velocity with a specified heatsink.

The typical test condition is shown in Figure 18

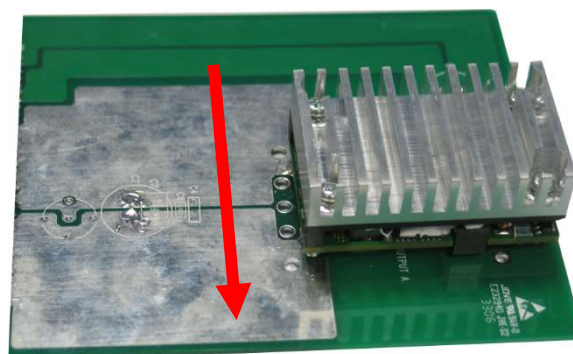

Figure 18 Typical test condition, Forced airflow direction is from Vin- to Vin+

ENVIRONMENTAL SPECIFICATIONS

Thermal Considerations - Baseplate Model Con't

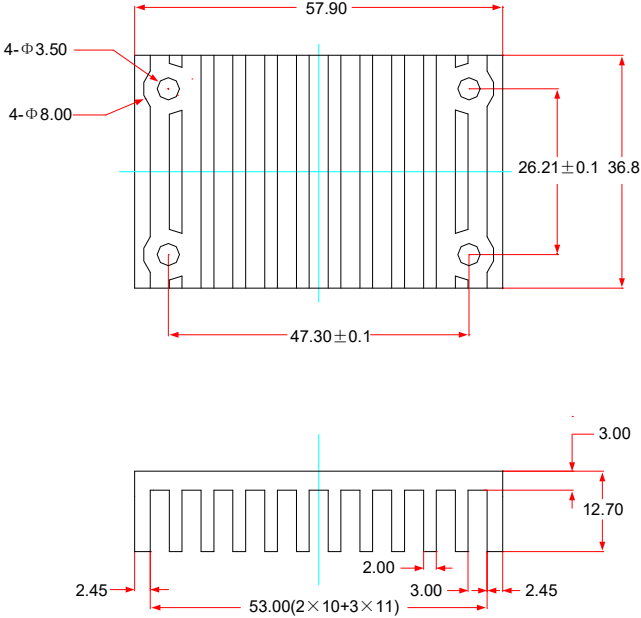

Figure 19 Outline drawing of the heatsink

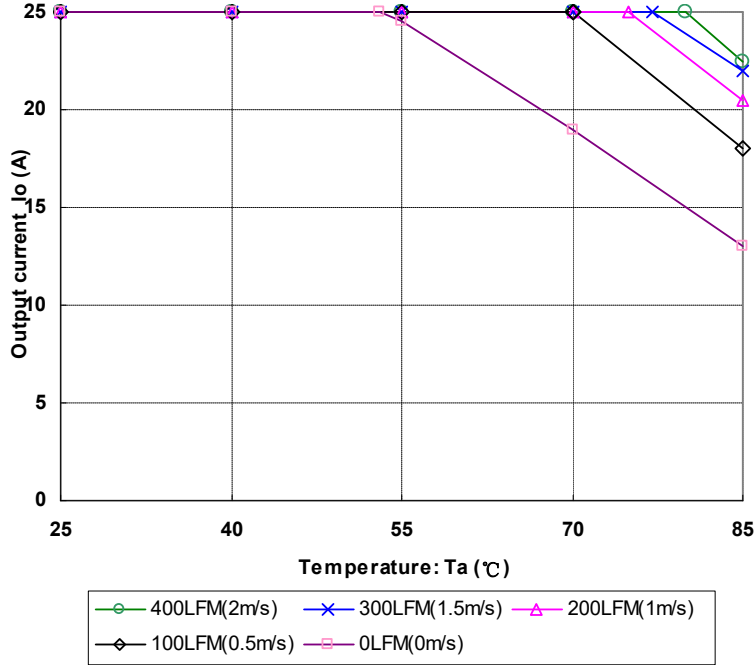

Figure 20 Output power derating, 48V_{in}, air flowing across the converter from V_{in-} to V_{in+}

ENVIRONMENTAL SPECIFICATIONS

Thermal Considerations - Baseplate Model Con't

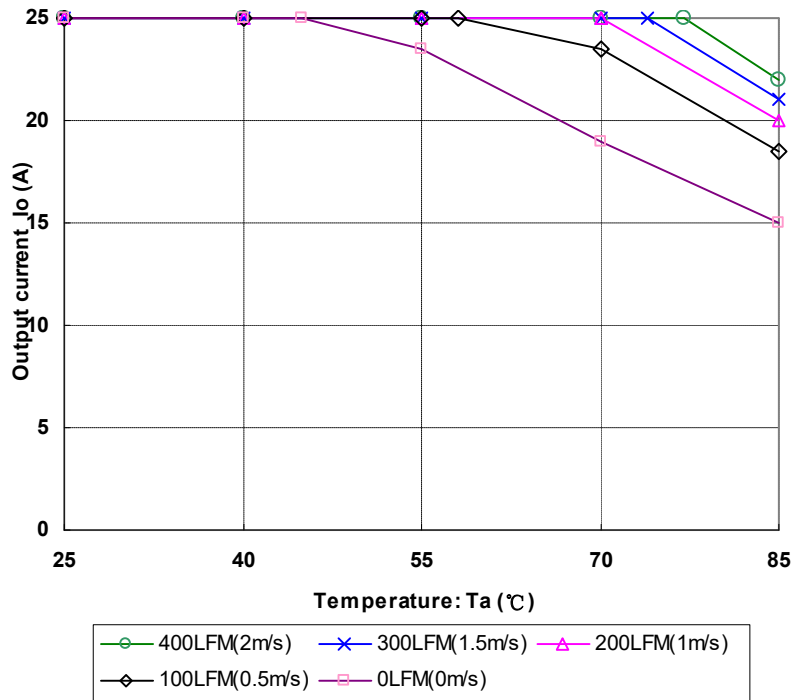

Figure 21 Output power derating, $24V_{in}$, air flowing across the converter from V_{in-} to V_{in+}

Assembly

The allowable maximum distance of the screw drove into heat-sink is 3.3mm.

ENVIRONMENTAL SPECIFICATIONS

Qualification Testing

Parameter	Unit (pcs)	Test condition
Halt test	4-5	$T_{a,min} - 10\text{ }^{\circ}\text{C}$ to $T_{a,max} + 10\text{ }^{\circ}\text{C}$, $5\text{ }^{\circ}\text{C}$ step, V_{in} = min to max, 0 ~ 105% load
Vibration	3	Frequency range: 5Hz ~ 20Hz, 20Hz ~ 200Hz, A.S.D: 1.0m2/s3, -3db/oct, axes of vibration: X/Y/Z. Time: 30min/axes
Mechanical Shock	3	30g, 6ms, 3axes, 6directions, 3time/direction
Thermal Shock	3	-40 $^{\circ}\text{C}$ to 100 $^{\circ}\text{C}$, unit temperature 20cycles
Thermal Cycling	3	-40 $^{\circ}\text{C}$ to 55 $^{\circ}\text{C}$, temperature change rate: 1 $^{\circ}\text{C}/\text{min}$, cycles: 2cycles
Humidity	3	40 $^{\circ}\text{C}$, 95%RH, 48h
Solder Ability	15	IPC J-STD-002C-2007

APPLICATION NOTES

Typical Application

Below is the typical application of the AVQ100-36S3V3 series power supply.

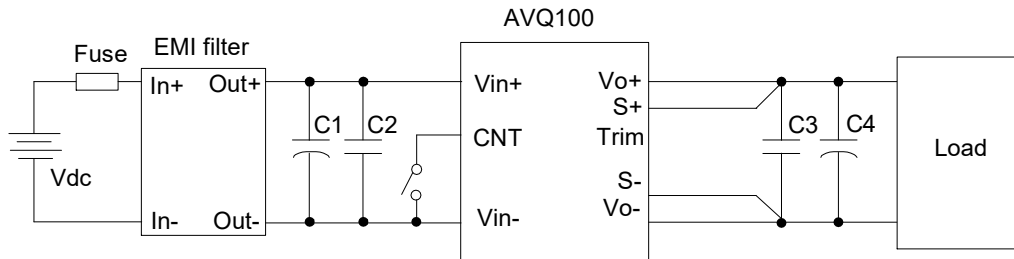

Figure 22 Typical application

C1: 100uF/100V electrolytic capacitor, P/N: UPW2A101MHD (Nichicon) or equivalent caps

C2: 1uF/100V X7R ceramic capacitor, P/N: C3225X7R2A105KT0L0U (TDK) or equivalent caps

C3: 1uF/25V X7R ceramic capacitor, P/N: C3225X7R1E105KT000N (TDK) or equivalent caps

C4: 470uF electrolytic capacitor, P/N: UUD1H471MNL1GS (Nichicon) or equivalent caps

Fuse: External fast blow fuse with a rating of 15A. The recommended fuse model is 0324020 MXP from LITTLEFUSE.

APPLICATION NOTES

Remote ON/OFF

Either positive or negative remote ON/OFF logic is available in AVQ100-36S3V3-4. The logic is CMOS and TTL compatible.

Below is the detailed internal circuit and reference in AVQ100-36S3V3.

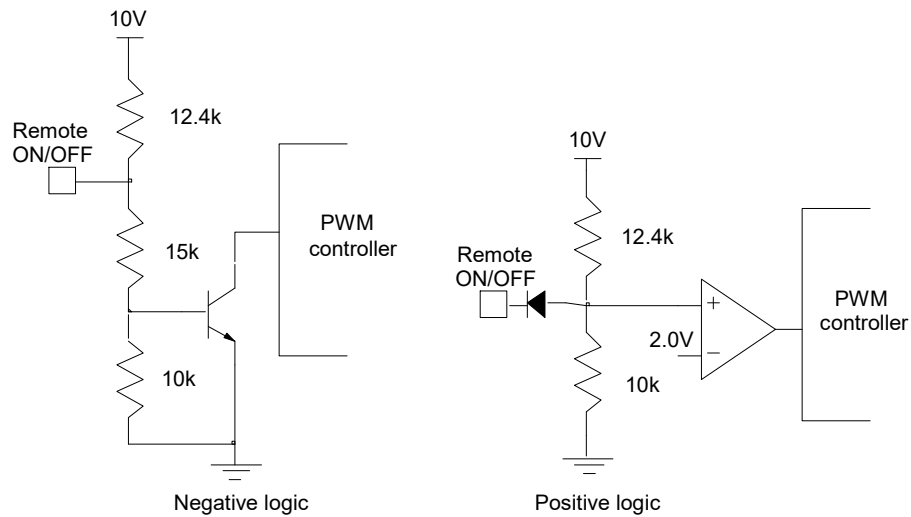

Figure 23 Remote ON/OFF internal diagram

APPLICATION NOTES

Trim Characteristics

Connecting an external resistor between Trim pin and Vo- pin will decrease the output voltage. While connecting it between Trim and Vo+ will increase the output voltage. The following equations determine the external resistance to obtain the trimmed output voltage.

$$R_{adj-down} = \frac{510}{\Delta} - 10.2(K\Omega)$$

$$R_{adj-up} = \frac{5.1 \times V_{nom} \times (100 + \Delta)}{1.225 \times \Delta} - \frac{510}{\Delta} - 10.2(K\Omega)$$

$$\Delta = \frac{|V_{nom} - V_{desired}|}{V_{nom}} \times 100$$

V_{Nom} : Nominal output voltage.

For example, to get 3.63V output, the trimming resistor is

$$R_{adj-up} = \frac{5.1 \times 3.3 \times (100 + 10)}{1.225 \times 10} - \frac{510}{10} - 10.2(K\Omega) = 89.9K\Omega$$

The output voltage can also be trimmed by potential applied at the Trim pin.

$$V_O = (V_{trim} + 1.225) \times 2.69$$

When trimming up, the output current should be decreased accordingly so as not to exceed the maximum output power and the minimum input voltage should be increased as shown in the following figures.

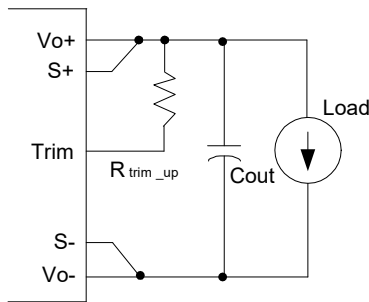

Figure 24 Trim up

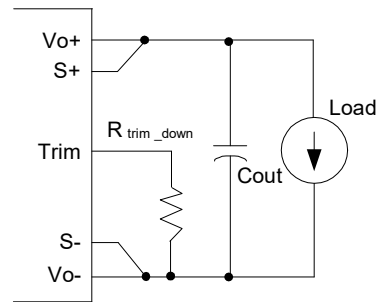

Figure 25 Trim down

APPLICATION NOTES

Input Ripple & Output Ripple & Noise Test Configuration

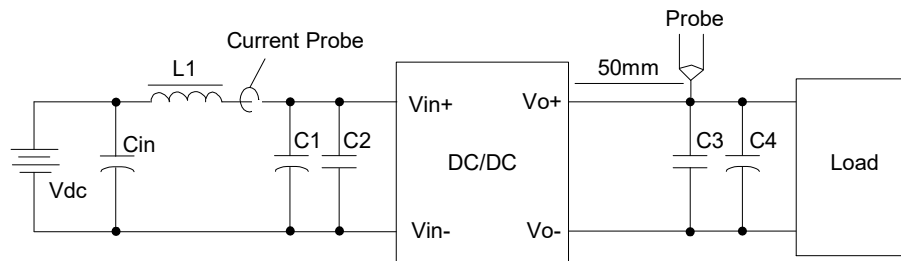

Figure 26 Input ripple & inrush current, ripple & noise test configuration

Vdc: DC power supply

L1: 12uH

Cin: 220uF/100V typical

C1 ~ C4: See Figure 22

Note: Using a coaxial cable with series 50Ω resistor and 0.68μF ceramic capacitor or a ground ring of probe to test output ripple & noise is recommended.

APPLICATION NOTES

Sense Characteristics

If the load is far from the unit, connect S+ and S- to the terminal of the load respectively to compensate the voltage drop on the transmission line. See Figure 22.

If the sense compensate function is not necessary, connect S+ to V_o+ and S- to V_o- directly.

SOLDERING INFORMATION

Soldering

The product is intended for standard manual or wave soldering.

	Product Requirement	Product Name
R6	Wave soldering	AVQ100-36S3V3-6L AVQ100-36S3V3B-6L

When wave soldering is used, the temperature on pins is specified to maximum 260 °C for maximum 7s.

When soldering by hand, the iron temperature should be maintained at 300 °C ~ 380 °C and applied to the converter pins for less than 10s. Longer exposure can cause internal damage to the converter. Cleaning of solder joint can be performed with cleaning solvent IPA or simulative.

The below products are intended for standard reflow soldering.

	Product Requirement	Product Name
R6	Reflow soldering	AVQ100-36S3V3-6L

When reflow soldering is used, Please refer to following fig for recommended temperature profile parameters.

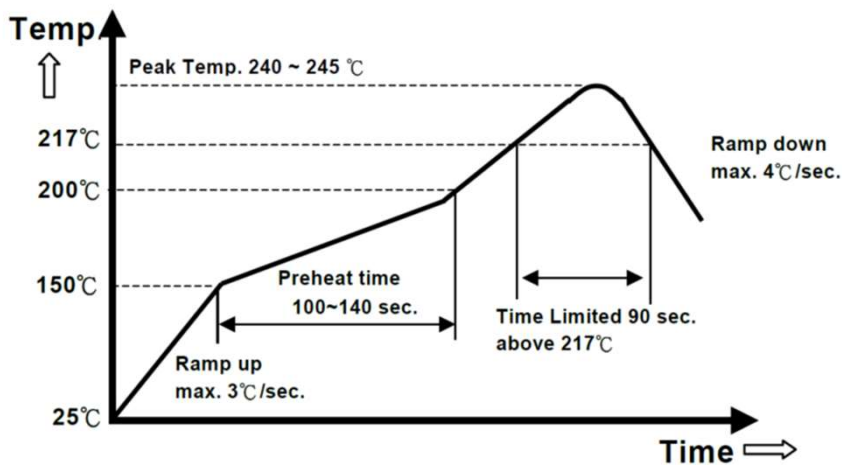

Record of Revision and Changes

Issue	Date	Description	Originators
1.3	02.27.2020	Update RoHS information	V.Guo
1.4	04.21.2021	Update Template	J.Zhang
1.5	09.15.2021	Add Note for Mechanical part Note: "6-Ø1.0" means there are 6 pins (Pins 1,2,3,4,5,6,7), the diameter of which is 1mm. "2-Ø1.5" means there are 2 pins (Pins 4,8), the diameter of which is 1.5mm.	K.Wang



For international contact information,
visit advancedenergy.com.

powersales@aei.com (Sales Support)
productsupport.ep@aei.com (Technical Support)
+1 888 412 7832

ABOUT ADVANCED ENERGY

Advanced Energy (AE) has devoted more than three decades to perfecting power for its global customers. AE designs and manufactures highly engineered, precision power conversion, measurement and control solutions for mission-critical applications and processes.

Our products enable customer innovation in complex applications for a wide range of industries including semiconductor equipment, industrial, manufacturing, telecommunications, data center computing, and medical. With deep applications know-how and responsive service and support across the globe, we build collaborative partnerships to meet rapid technological developments, propel growth for our customers, and innovate the future of power.

PRECISION | POWER | PERFORMANCE

Specifications are subject to change without notice. Not responsible for errors or omissions. ©2020 Advanced Energy Industries, Inc. All rights reserved. Advanced Energy®, and AE® are U.S. trademarks of Advanced Energy Industries, Inc.