

GLASS SOLUTIONS

Non-contact temperature sensors, SCR power controllers, and plasma power generators for improved process control, monitoring, and greater efficiency in glass production processes.



Trusted Solutions

For decades, our instruments have been used in continuous and batch glass manufacturing processes around the world, where robustness and reliability are critical.

Advanced Energy delivers trusted temperature measurement and control solutions for glass manufacturers. Accurate and precise temperature monitoring is critical for efficient and cost-effective melting, glass viscosity control, heat zone adjustment, annealing, and stress reduction.

Temperature measurement is also directly related to glass quality as well as prolonging the life of critical assets such as refractory walls. System solutions with SCR power controllers, involving Mikron non-contact thermal imaging combined with Impac® pyrometry by Advanced Energy can help increase production efficiency and reduce waste.

Accurate temperature control during the heating up and cooling down processes has an impact on the quality and reliability of the finished glass. That applies to all stages at the “hot end” of the production

process, from melting to the final annealing. Extreme reliability and precision are key for any successful production plant, as a breakdown at any one of the individual stages would bring the entire production process to a standstill.

Our unrivaled passion for excellence is why we have become one of the world’s most trusted sensing solution providers. Beyond providing precision engineered products, our customers turn to us knowing our commitment to their success comes first. With expert application understanding and a growing portfolio of products, Advanced Energy combines several technologies together into novel solutions for the most complex environments.

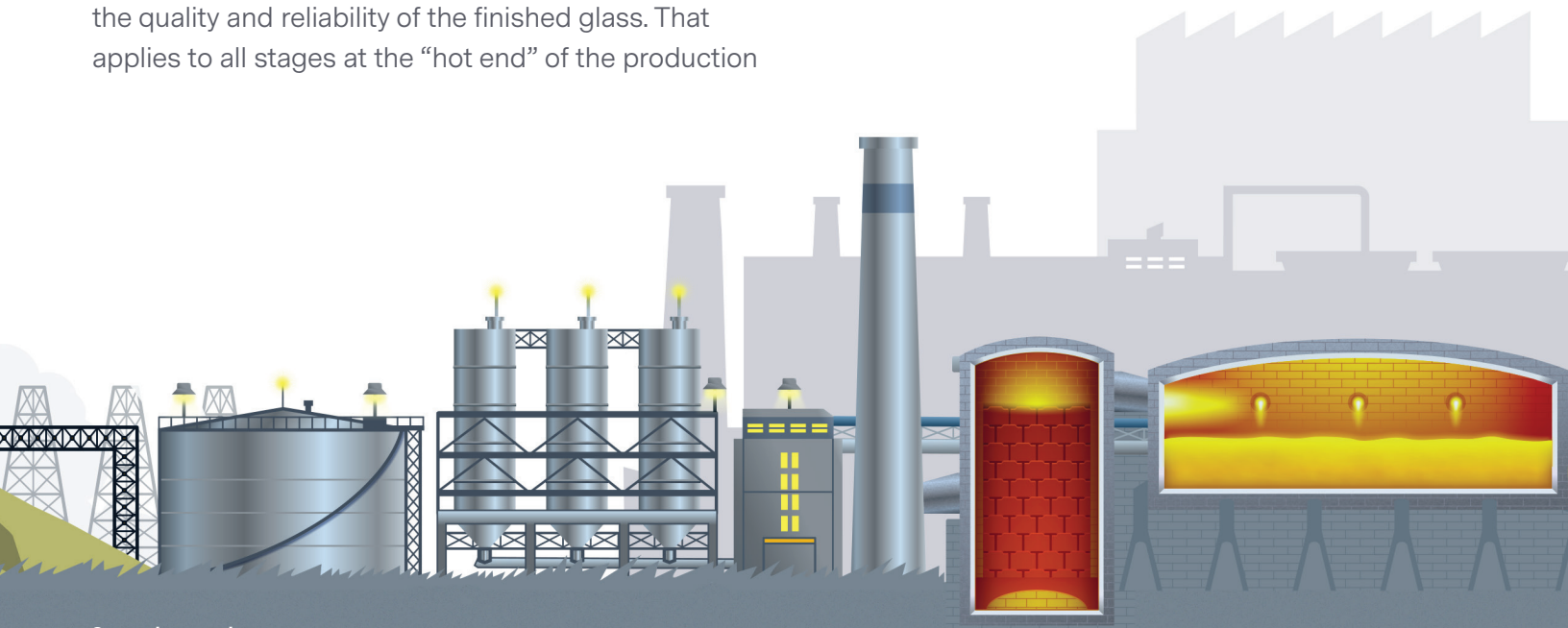

Common Applications



Flat and solar glass

e.g., for the architectural and automotive sectors



Thin and thinnest sheet glass

e.g., for smart phones, tablets, flat panel displays, solar panels, and safety glass



Container and utility glassware

e.g., for bottles, containers, and drinking glasses



Technical glass

e.g., lamps, lightbulbs, energy-saving lamps and tubes, optical glass fiber, glass wool, and optical instruments

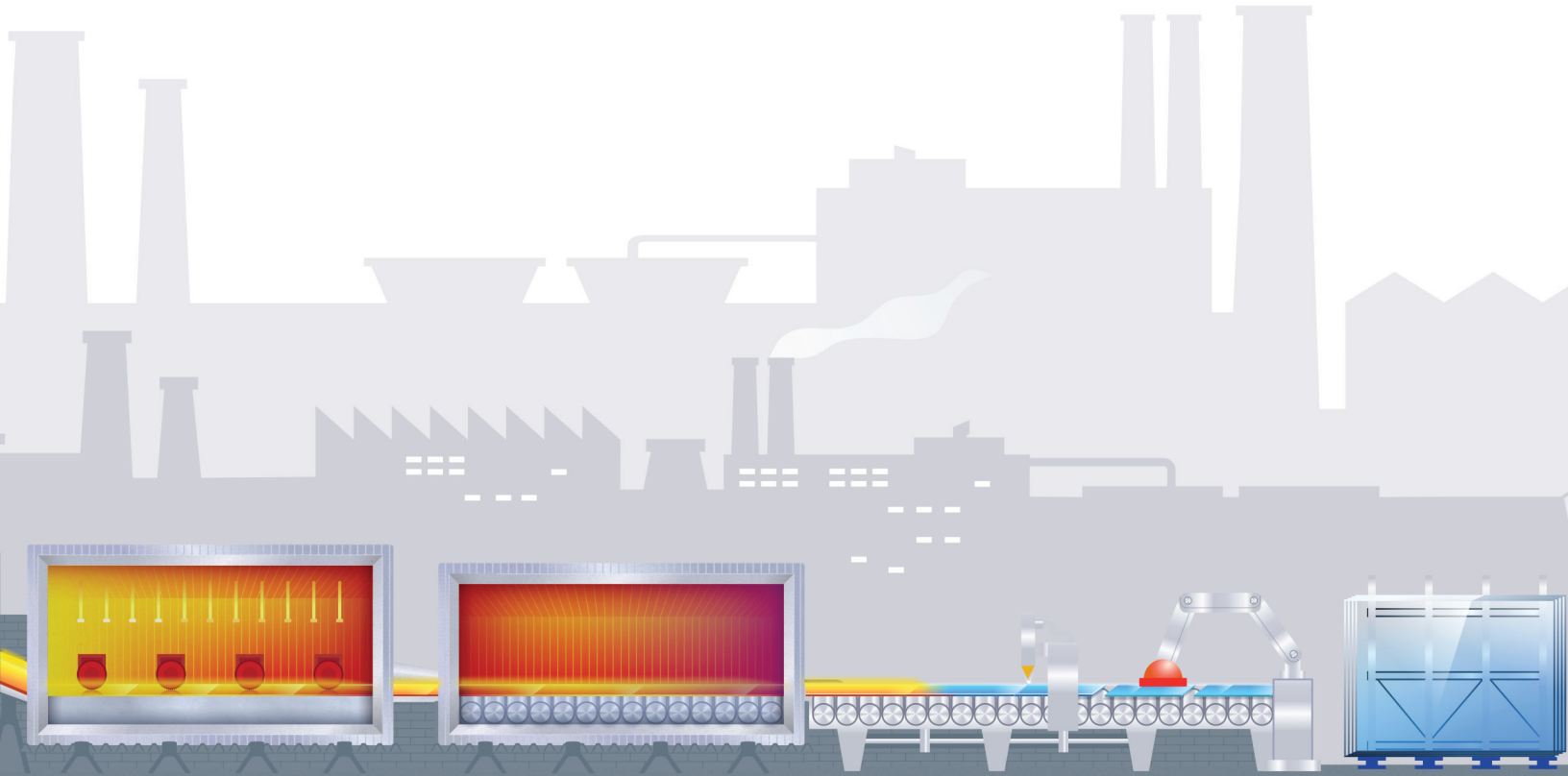

Process Optimization Through Precise Control and Non-Contact Temperature Measurement

Temperature measurement and control is key to the monitoring and optimization of energy-intensive glass production processes.

Careful temperature monitoring during glass production is the only way to ensure product quality meets stringent marketplace requirements. While temperature control has an impact on the actual quality and reliability of the finished glass, it all comes together when the individual coating layers are added.

Temperatures during various production stages are mostly measured without contact (e.g., in the glass melting tank, working tank, feeder, or gob).

The principal advantages of non-contact measurements are:

- Easy handling
- High flexibility
- Fast response
- Prolonged service life
- Increased throughput rates
- No contamination of molten glass

Digital measuring equipment with compact electronic components guarantees fast and precise temperature measurements with excellent repeatability. Our solutions work together closely so that measurements can immediately be adjusted and controlled by the temperature control devices.

Advanced Energy offers unmatched experience in non-contact measuring and power control technologies as well as power solutions with four product lines:

PYROMETERS	THERMAL IMAGERS
SCR POWER CONTROLLERS	PLASMA POWER GENERATORS

Choose from a wide range of non-contact thermometers, SCR power controllers, and DC power systems whose ruggedness and precision are tailored to specific needs of the glass industry.

Whether it be for flat glass, solar glass, container glassware, utility glassware, or technical glass, all of our products deliver fast and accurate temperature readings. Customers receive optimum solutions to their specific challenges through intensive consultation with our sales and application engineers.



Emissivity of Glass in the Infrared Spectrum

Important optical properties of flat glass transmission (τ), reflection (ρ), and emissivity (ϵ) (or absorption (α)) affect the performance in many common applications.

The high energy UV portion of the solar spectrum (wavelength less than 400 nm) can be damaging to many materials including human skin. Since the transmission of glass is relatively low in this region, thick glass can be an effective UV block. Visual light (400 to 750 nm) easily passes through glass since the transmission is very high in this region. For the longer wavelength near infrared radiation (NIR) (750 to 2500 nm), which is the heat-generating portion of the solar spectrum, a large fraction also passes through glass as the transmission is relatively high. Coatings can be applied to the glass surfaces prior to annealing to raise the reflectivity (ρ) of glass in the NIR region. This 'low-E' glass can help to reflect and retain heat generated inside a building during cool conditions, and it can reflect heat from the sun during warm days.

New materials and layer stacks requiring advanced plasma technologies are being developed to address these needs. This pushes glass coating companies to enhance capabilities on existing and new coaters. Therefore, stable, reliable, precision process power with repeatability is needed for today's glass coating production. With advanced arc management, pulsed-DC, and bipolar-pulsed DC power systems, new technologies are offered to increase glass value and coater productivity, reducing the overall cost of ownership.

During glass manufacturing, accurate control of the process temperatures is critical to ensuring a quality product. Especially for infrared temperature measurement systems used in glass applications, it is most important to know the significance of process parameters to select the correct instrumentation. A pyrometer or thermal imager with a detector that is sensitive at 1 μm can be used to look through thin glass and measure wall temperatures as the glass emissivity is small and transmission is large. If there is sufficient glass thickness such as in the melt tank, then the bulk glass temperature can be measured. For thinner glass, selecting detectors that are sensitive in the 5 to 8 μm range will ensure very high emissivity and accurate measurements on the surface of the plate. A 3.9 μm detector can be used to measure the temperature a few millimeters down into the glass.

SCR power controllers precisely regulate power, including load management, for optimal control and energy consumption during the entire glass making process.

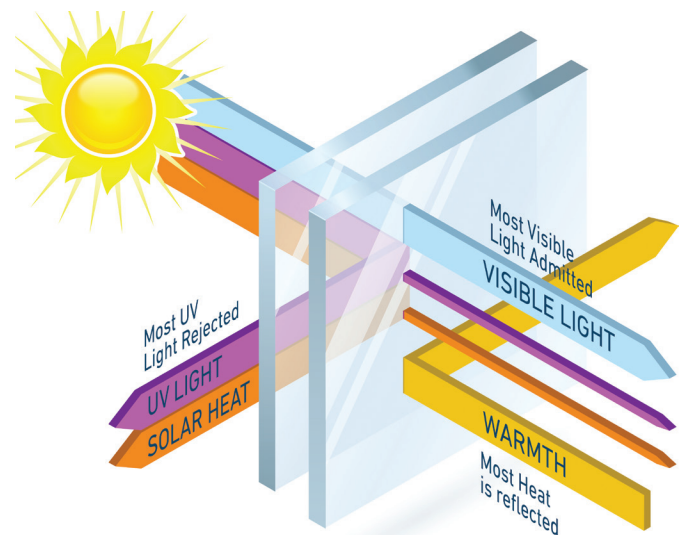
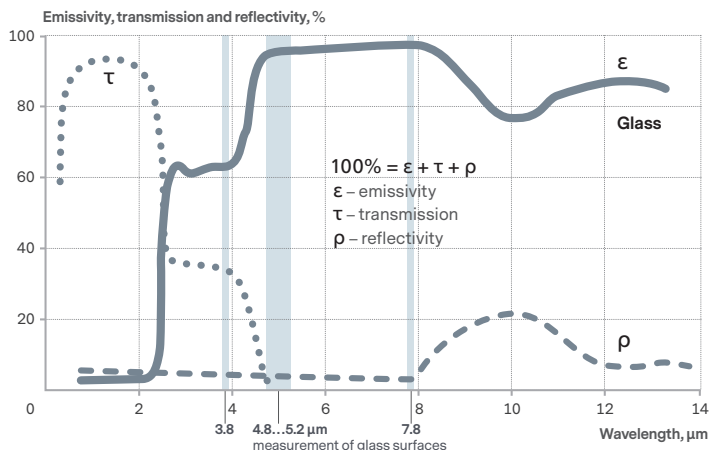

Glass Melting

Regenerator

Protecting the expensive regenerator crown refractory is important in the glass melting process. Typical thermocouples deteriorate over time and can be unreliable, but infrared pyrometers measure temperature without contact and remain outside high-temperature zones, providing long-term reliability. This enables operators to maintain efficient and stable operation of the melting tank at higher temperatures.

Melting Tank

Sand, limestone, soda ash, and cullet feed are melted in a furnace at high temperatures. Protecting the expensive melting tank crown, walls, and bottom refractory from excessive temperature of the corrosive molten glass is essential for longevity.

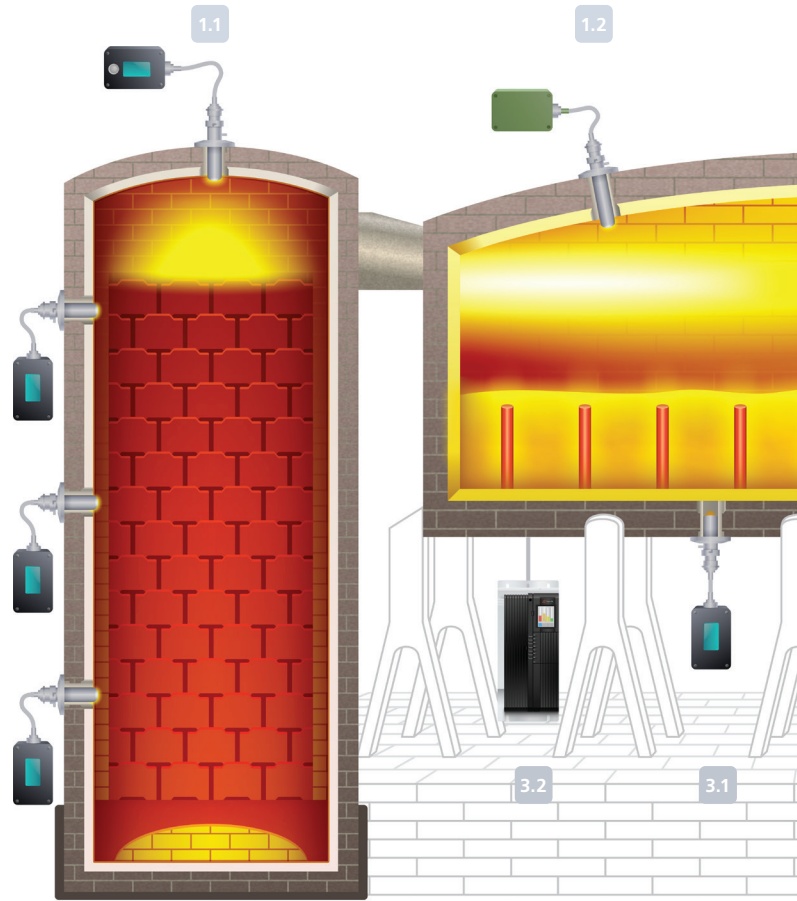

Regenerator

01 Checking the melting tank temperature

Challenges

Ensuring the correct melting temperature through infrared temperature measurement in this area.

Wear-resistant temperature measuring systems delivering continuous, reliable data.

Advanced Energy's solution

Rugged fixed-installation instrument that has a closed ceramic or Inconel tube or with a handheld precision instrument.

Customer benefits

Avoiding glass runout due to refractory failure and high costs resulting from loss of production.

1.1 Roof-mounting

SOLUTIONS: Series 50-LO plus pyrometers with open Inconel or closed ceramic tube.

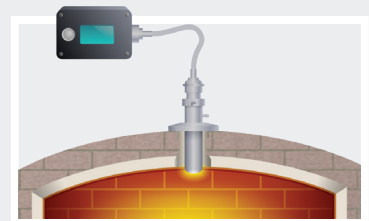

1.2 Fixed installation pyrometer

SOLUTIONS: Series 50-IS-LO/GL pyrometers with open Inconel or open or closed ceramic tube.

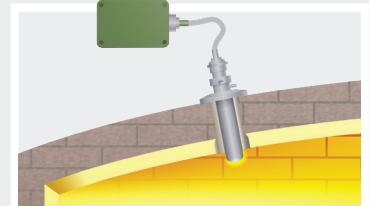

1.3 External "hot spot" monitoring

SOLUTIONS: MCL640 thermal imaging camera.

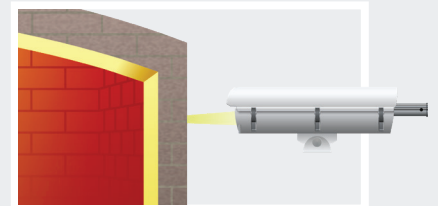

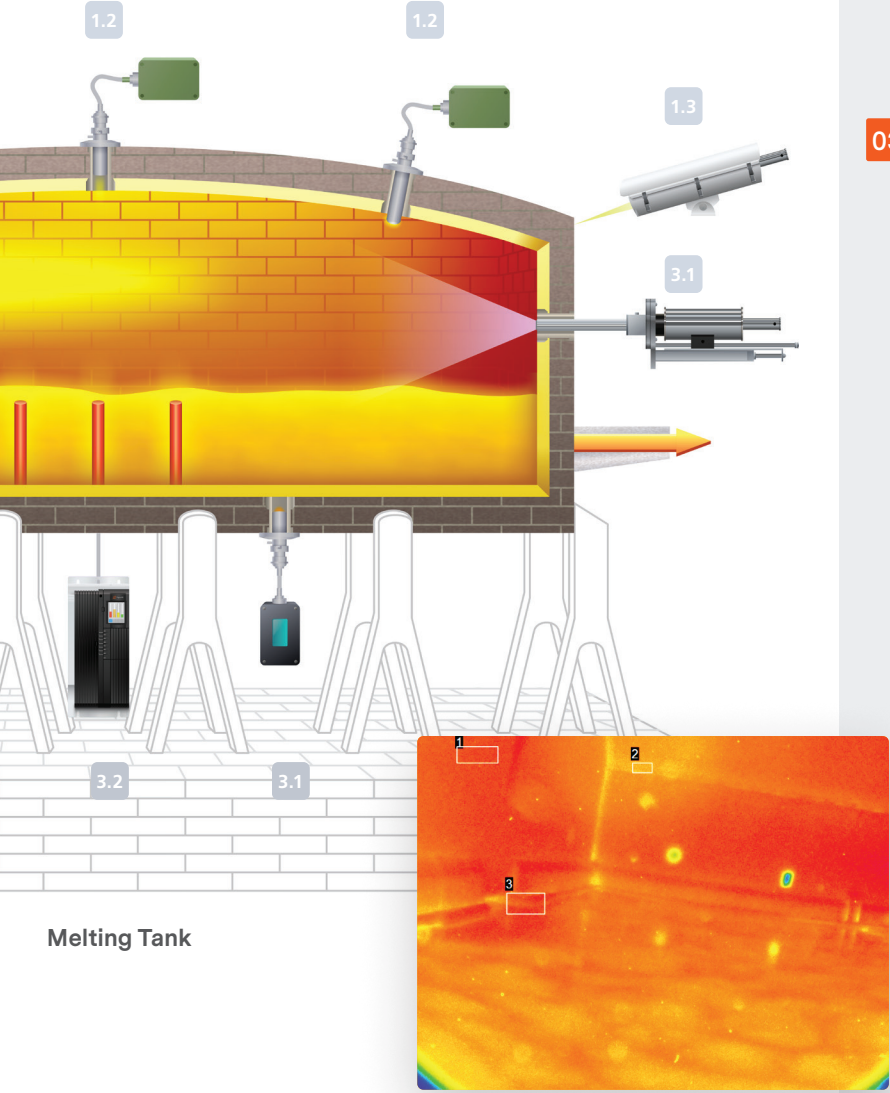

Melting Tank

03 Monitoring the tank bottom temperature

Challenges

Early detection of elevated temperatures in the bottom area of the melting tank caused by erosion of the refractory lining.

Advanced Energy’s solution

FurnaceSpection thermal imaging system for inspection of the melting tank bottom. By continuously monitoring surface temperature, the condition of the bottom refractory can be calculated and monitored, enabling the prevention of unexpected early failure.

Customer benefits

Early detection of wear in insulation materials allows for scheduling of corrective maintenance activities.

Prevention of glass runouts through the tank bottom, resulting in less frequent repairs and expensive stops in production.

3.1 Fixed-installation instruments at multiple locations

SOLUTIONS: FurnaceSpection, Series 520, and Series 600 pyrometers.

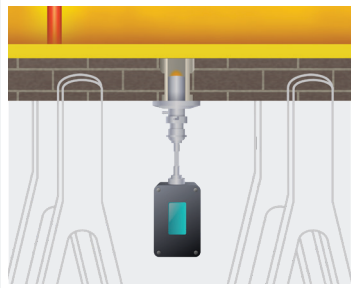

3.2 Digital SCR power controller series

SOLUTIONS: Intelligently manage electrical energy used in glass process and offer insight to precisely regulate and control temperature and power.

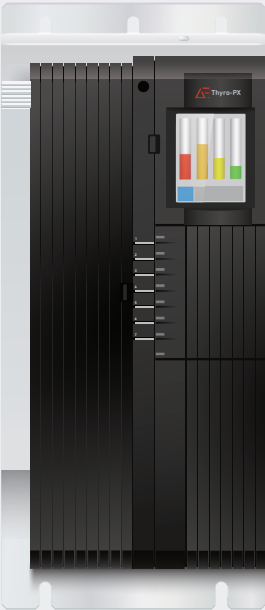

02 Checking the temperature

Challenges

Continuous measurement of end-wall temperatures for early detection of potential refractory failures.

Advanced Energy’s solution

Robust handheld Series 8 Pro instrument with through-the-lens sighting for direct readings, high grade optics for detection of contours, and ultra-small measuring spots.

Alternative: Stationary measurement with IS 50-LO/GL.

Customer benefits

Flexible inspection capabilities to monitor critical areas and prevent dangerous refractory failures at the end wall.

Flat Glass

Tin Bath

The tin bath is the key component in the modern float glass process. Molten glass from the melting tank enters the tin bath through a canal and floats on top of the molten tin.

Near the entrance of the controlled chamber, temperature is kept high to allow the molten glass to spread and smooth out. The glass is then allowed to cool in the various heating/cooling zones. Ensuring proper temperature of these cooling zones is essential to maintaining uniformity.

Annealing Lehr

After the glass ribbon is properly formed, it is moved through the lehr where it cools slowly for annealing. Considerable mechanical stress may develop in the glass as it cools down.

Advanced Energy's proven combination of SCR power controllers, pyrometers, and thermal imagers enable optimum monitoring and control to ensure a smooth process flow during this extremely temperature-critical step.

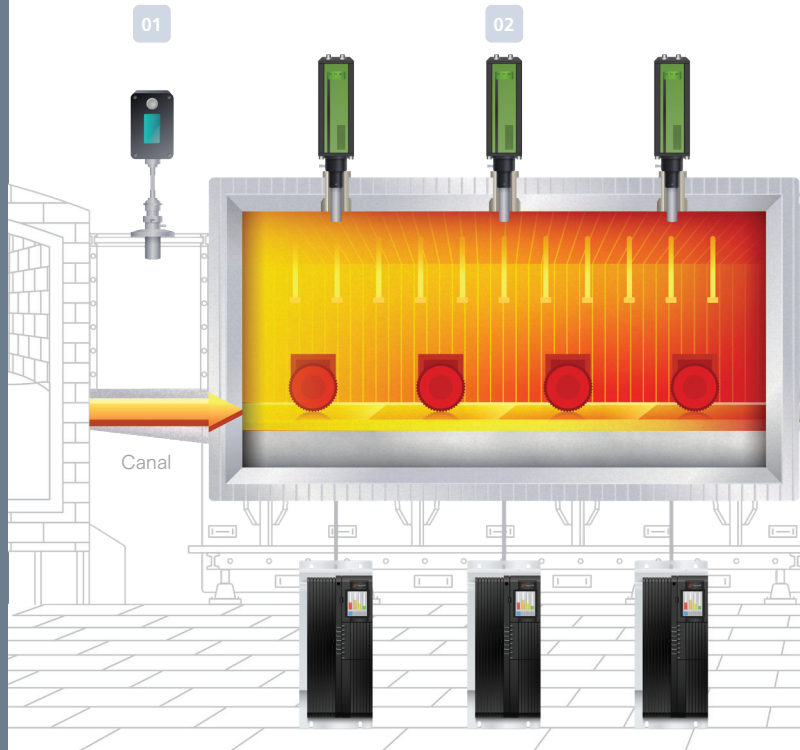

Tin Bath

01 Reviewing the glass temperature in the canal

Challenges

The glass discharged by the melting tank must have a minimum temperature of 1100°C before it enters the tin bath.

Advanced Energy's solution

A monitoring solution with a long fiber optic cable and open-ended ceramic or inconel tube as a radiation shield.

Customer benefits

Reliable adjustment of correct starting temperature for the complete down-stream process.

Adjustment of glass flow rate via its viscosity.

Cost reductions through closed-loop temperature control within tight tolerances.

SOLUTIONS:

Series 50-LO/GL pyrometers with open-ended ceramic or inconel tube.

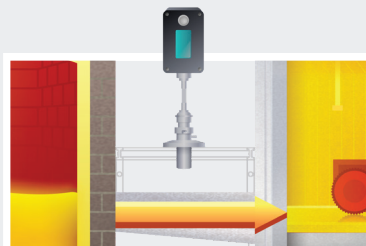

02 Measuring and controlling temperature distribution in the tin bath heating zone

Challenges

Ensure requisite temperature distribution in the molten glass and a smooth process flow within the tin bath heating zone.

Advanced Energy's solution

A monitoring solution with an open-ended ceramic or inconel tube as a radiation shield. Precisely and reliably regulate each heating zone and monitor setting points.

Customer benefits

Reliable implementation of correct cooling rates and closed-loop control of heat input.

Cost reductions through optimized use of energy.

SOLUTIONS:

IPE 140/39 or IN 5/5 plus pyrometer, Thyro-PX or Thyro-A+ SCR power controller.

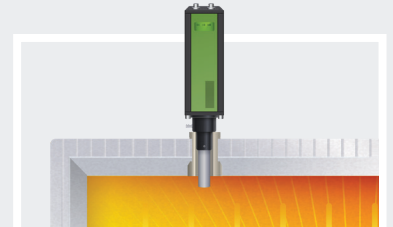

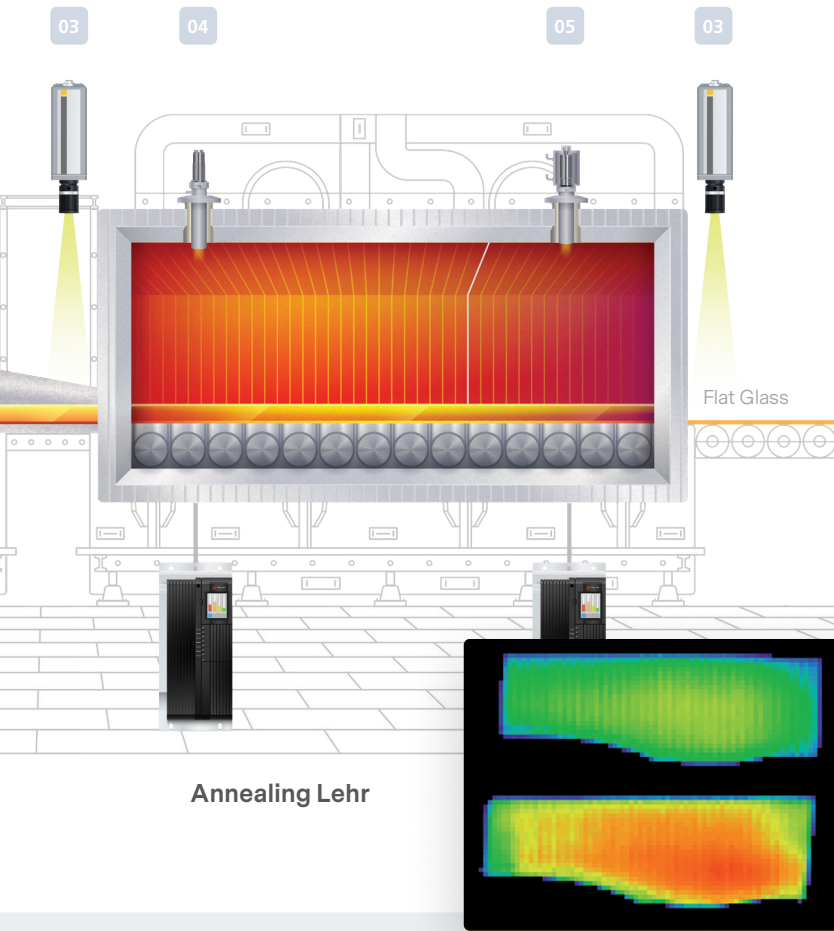

Annealing Lehr

03 Measuring the temperature distribution across the flat glass ribbon

Challenges

Ensure homogeneous temperature distribution in the glass as it enters and leaves the working tank.

Advanced Energy's solution

Thermal imagers for fast and full coverage temperature monitoring across the entire width of the flat glass ribbon.

Customer benefits

Rapid visualization of temperature distribution by means of thermal imaging software for easy, manual readjustment of heat input. Automatic alarms when limit values are exceeded.

SOLUTIONS:
MCL640 thermal imaging camera.

◀ Thermal image of two glass panes.

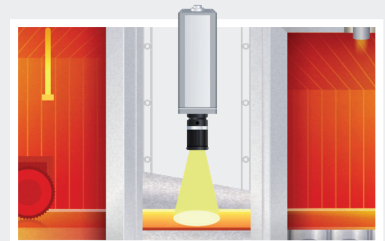

04 Measuring surface temperatures in the annealing lehr

Challenges

Relieve all mechanical stresses induced in the glass before further processing and packing. Process optimization through closed-loop control of the heating elements in the annealing lehr.

Advanced Energy's solution

Proven pyrometers with rugged sensors and a flat glass calibration feature tailored to the specific mounting conditions and ambient radiation.

Customer benefits

Closed-loop control of heating elements with accurate acquisition of flat glass temperature.

Quality assurance and efficient use of energy.

SOLUTIONS:
Series 5/5 incl. special flat glass calibration or IN 6/78-L for ultra-thin glass sheets.

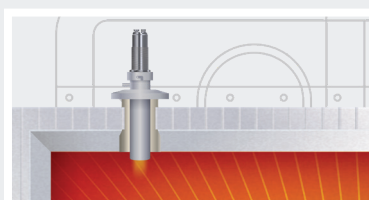

05 Monitoring of annealing lehr discharge temperature

Challenges

Ensure the requisite glass temperature after the cooling phase.

Advanced Energy's solution

A reliable low-temperature pyrometer in a stainless steel protective enclosure. Rugged two-wire system with analog signal transmission.

Customer benefits

Observance of correct material cooling rate for production of flat glass with few internal stresses.

Prevention of glass breakage due to thermal shock upon entry into normal atmosphere.

SOLUTIONS:
Series 5/5 incl. special flat glass calibration and protective enclosure.

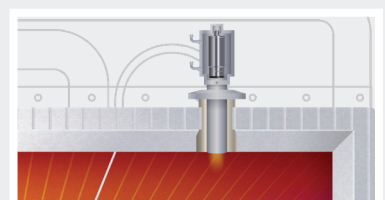

Container Glass



In the production of container glassware, closely controlled temperatures are key to shaping the glassware and to achieving energy savings. Advanced Energy's pyrometers and thermal imagers facilitate the adjustment of the temperature distribution and closed-loop control of the feeder temperature.

01 Measuring and controlling the temperature distribution in the working tank

Challenges

Ensure homogeneous temperature of the molten glass exiting the working tank.

Advanced Energy's solution

A monitoring system for repeatable temperature readings and precise heating zones.

Customer benefits

Reliable cooling rates, adjustments of glass flow rate, and optimized energy.

SOLUTIONS:

IS 50-LO Plus pyrometer.
Thyro-PX or Thro-A+ SCR power controller.



02 Measuring the temperature gradient in the feeder

Challenges

Continuous measurement and control of the material flow. Minimized energy costs in the heating process.

Advanced Energy's solution

Proven application packages featuring high measuring accuracy, excellent repeatability, and long service lives.

Customer benefits

Quick installation thanks to easy and reliable integration of components.

Optimized use of energy and adjustment of glass flow rate.

SOLUTIONS:

Series 50-LO/GL pyrometer with open-ended ceramic or Inconel tube. Thyro-PX or Thyro A+ SCR power controller.

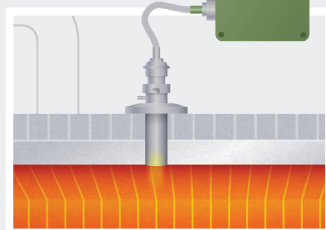

03 Measuring the gob temperature

Challenges

Ensure the desired container wall thickness via the core temperature of the gob.

Advanced Energy's solution

Rapid ratio pyrometer with small measuring spots.

Customer benefits

Reliably achieving the correct gob temperature prior to the next step in the process (IS machine).

SOLUTIONS:

Series 6 pyrometer including protective enclosure.

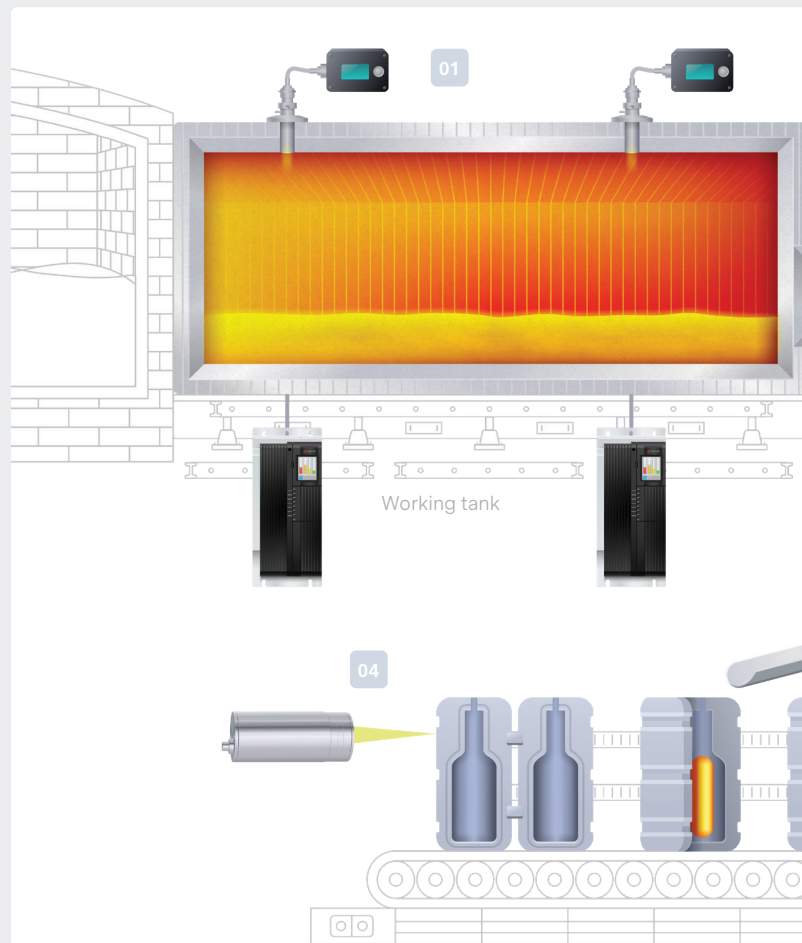
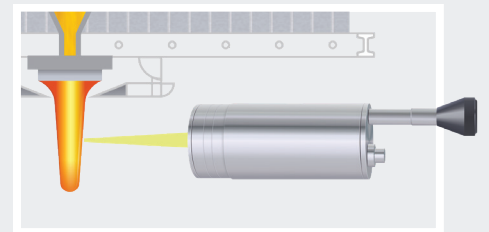

04 Measuring the mold temperature inside the IS machine

Challenges

Precise control of the air flow rate used for blowing and adjustment of the temperature distribution in the water-cooled mold. This forms the gob of glass into the desired shape with the requisite wall thickness.

Advanced Energy’s solution

Pyrometer for mobile inspections or fixed installed pyrometer.

Customer benefits

Optimum uniformity of container wall thickness.
Optimum adjustment of coolants.

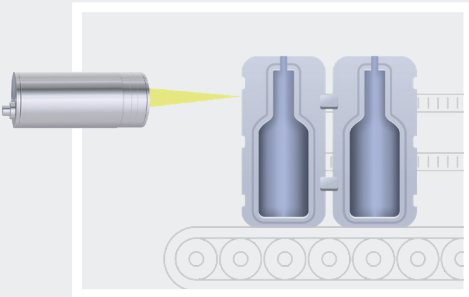

SOLUTIONS:
Series 6 (stationary) and Series 320 pyrometers.

05 Final check and control of material distribution

Challenges

Save raw materials with a view to optimizing energy efficiency throughout the complete forming process.

Advanced Energy’s solution

High resolution thermal imager with a spectral filter for glass surfaces and image processing software for automatic detection of defects.

Customer benefits

General optimization of molds through visualization of glass wall thicknesses and localization of thin container walls.
Automated mold parameter set-up through optional coupling of the system to the PLC for data correlation.

SOLUTIONS:
Thermal imaging.

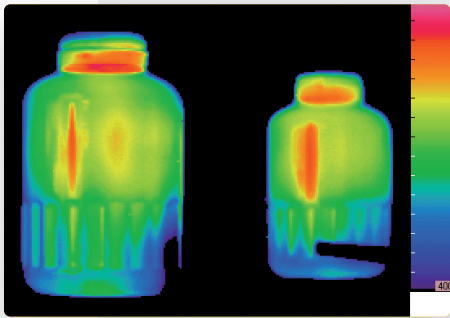
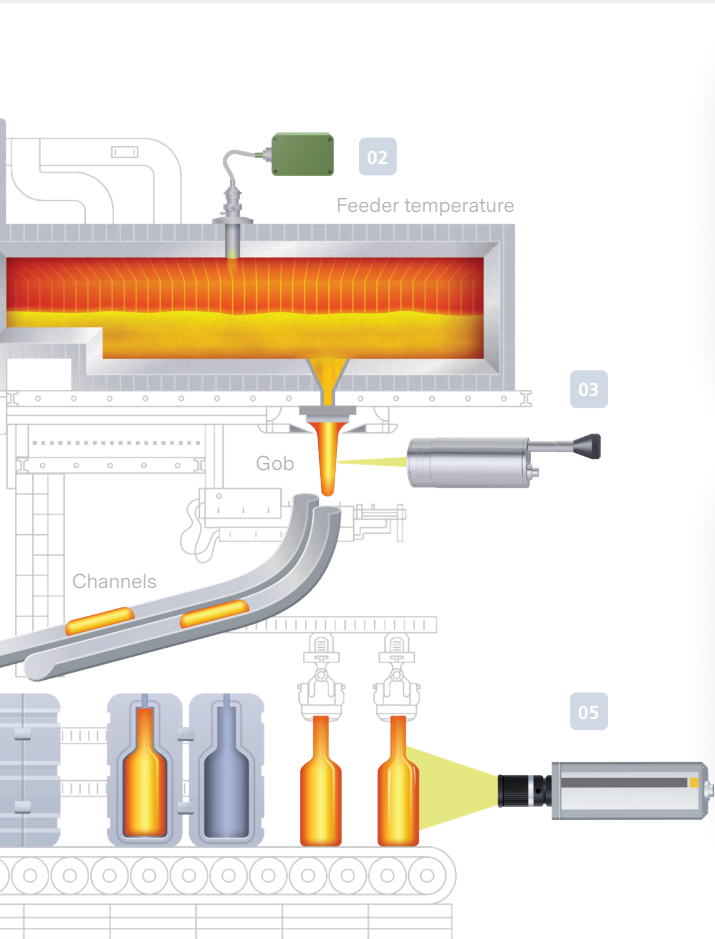
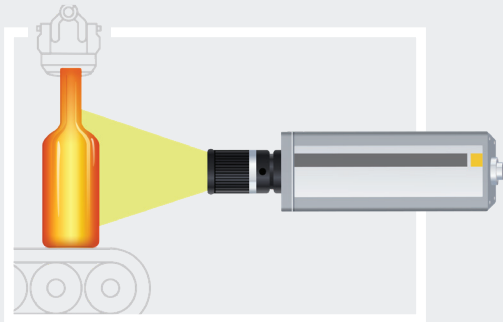

◀ **Thermal image taken without spectral filter for glass surfaces.** The interference from resulting ambient reflections causes direct measuring errors.

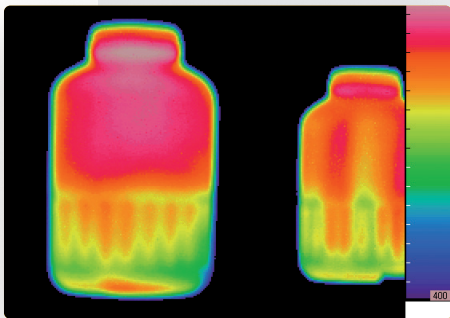

◀ **Thermal image taken with spectral filter for glass surfaces at 5 µm.** Ambient reflections are filtered out to minimize direct measuring errors.

Technical Glass

Manufacturing of technical glass is subject to particularly stringent quality requirements. The only way to achieve the desired quality and required service life of the product is to observe very close tolerances with regard to material temperatures throughout the entire process.

Pyrometers and thermal imagers from Advanced Energy are highly accurate temperature sensors and fulfill all prerequisites for successful compliance with quality requirements.

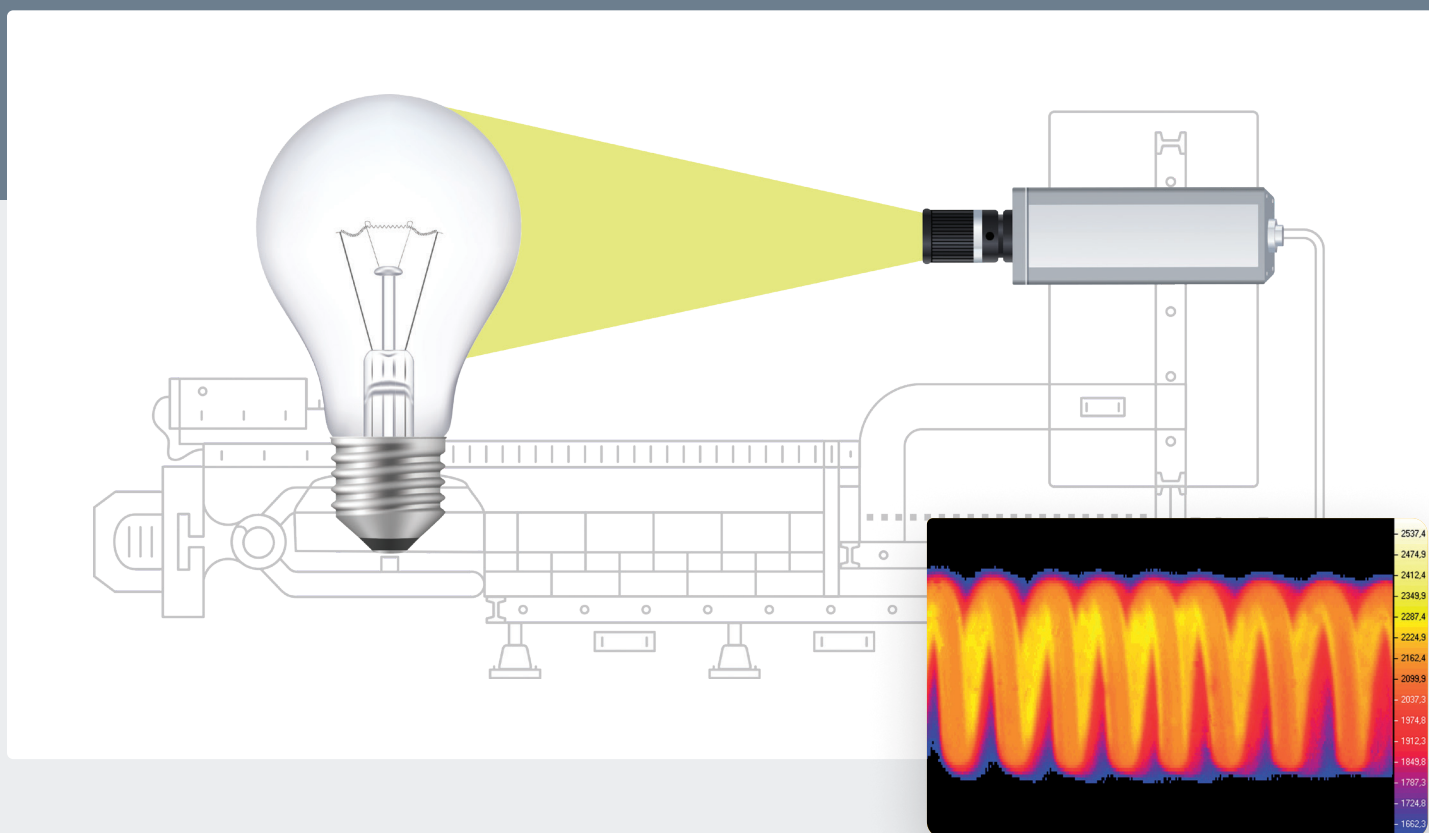

01 Measuring incandescent coils

Challenges

Optimization of temperature distribution in the incandescent coil.

Advanced Energy's solution

A fixed-installation thermal imaging system designed to measure very high temperatures on metals.

Real-time thermal imagery of temperature distribution and comprehensive data analysis and reporting features.

Customer benefits

Precise temperature measurements during the development phases of lamps and luminaires enable optimization of material properties and performance parameters.

This helps to considerably improve the service life of series production articles.

SOLUTIONS: Thermal imaging.

02 Rotary blow-molding machine

Challenges

Optimized efficiency of gas burners and reliable adjustment of requisite material temperature.

Advanced Energy’s solution

Measuring the glass temperatures between the heating stages using fixed pyrometers.

Customer benefits

Indirect measurements for optimized burner efficiency and precise closed-loop control of glass temperatures.

One key aspect of this solution is that gas consumption is optimized and energy costs are cut.

SOLUTIONS: IPE 140/39, IN 140/5, IN 5/5 Plus pyrometers.

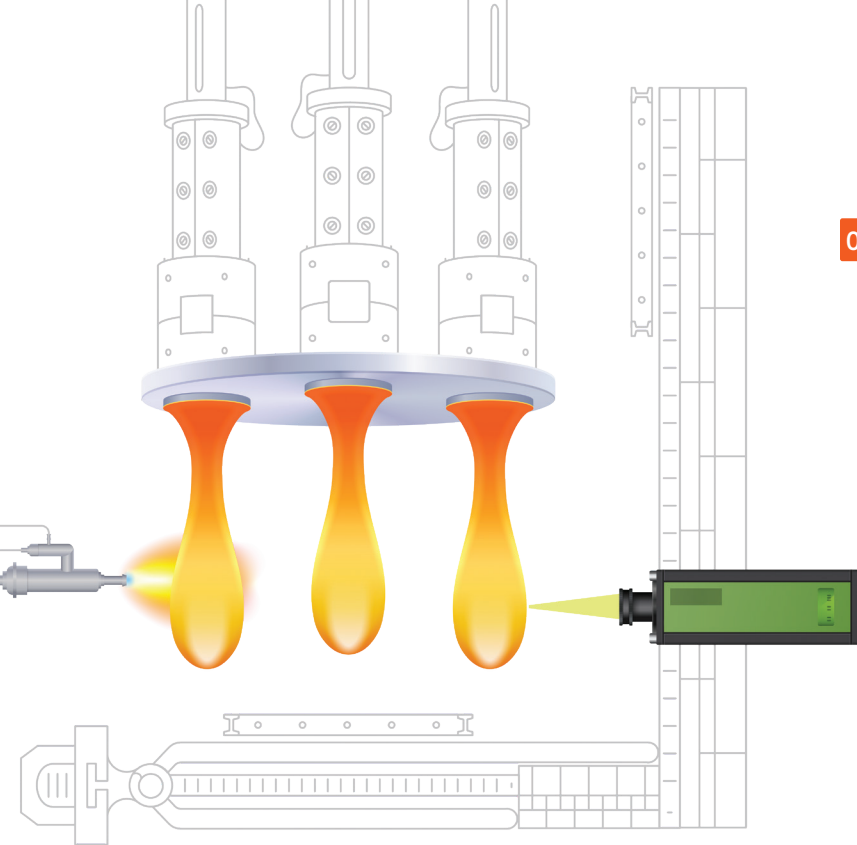

03 Measuring the temperature of glass dishes before entering the cooling lehr

Challenges

The temperature of the dishes must be measured to guarantee the desired material properties.

Advanced Energy’s solution

Pyrometers for rapid data acquisition with small measuring spots and reliable data transfer. The use of a fast measuring instrument allows for scanning of a large number of measuring points on the dish as it passes on the conveyor.

Customer benefits

Optimized use of energy in the forming process and monitoring of dish temperatures.

SOLUTIONS: IN 140/5-H, IN 5/5-H Plus pyrometers.

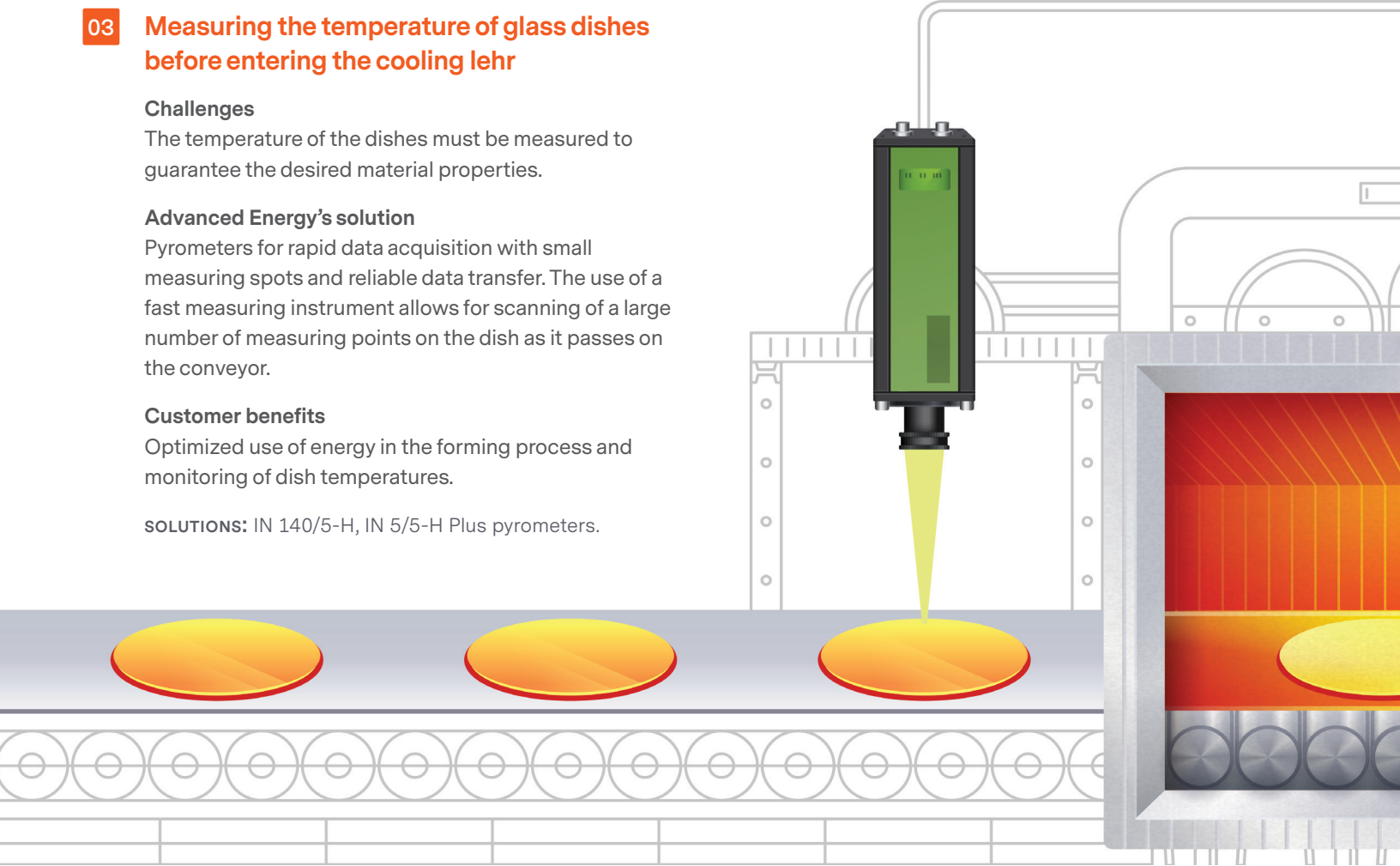



Constant and Precise Control

Discover AE's wide variety of precise products
for your glass manufacturing processes

Pyrometers

Trusted, non-contact pyrometers for precise and stable temperature measurement at every critical stage of glass production.



Series 600

Series 600 pyrometer with multiple temperature-resistant sensor heads for use in ambient temperatures up to 180°C.



IN 5/5

Compact, digital pyrometer for temperature measurement of glass and quartz glass surfaces with temperature ranges between 100 to 2500°C.



IPE140/39

Digital pyrometer for measuring the glass surface of the tin float tank and the lehr bath.



Series 8 Pro

Rugged, high-end handheld pyrometers for medium to high temperatures.



Series 520

Digital infrared pyrometers with temperature-resistant miniature sensor head for use in ambient temperatures up to 180°C.



IS 50-LO/GL

Digital infrared thermometer with fiber optics, specially designed for IR-measurement of bulk melt glass in the melt tank, working end, forehearth, and feeder.



ISR 6 Advanced

Digital ratio pyrometer with one-color and two-color modes.

ISR Advanced takes non-contact measurements between 600 to 3000°C. It is used for glass gob temperature measurement.



IN 6/78

Robust digital pyrometer for non-contact temperature measurement of thinnest glass surfaces.

It uses a special 7.8 μm wavelength for measurements on glass surfaces below 1 mm thickness accurately and reliably. Specially coated high-end optics are integrated, reducing ambient reflectance and guarantee best possible accuracy.



Series 50-LO plus

Digital pyrometer with fiber optic sensorhead.

Series 50-LO plus instruments are also used for measuring brickworks in the regenerator and melt tank. The robust fiber optic sensor enables instrument use in ambient temperatures up to 250°C without cooling.

Thermal Imagers

Turn-key solution that will withstand the harsh environment, provide high-quality infrared data, and integrates with your glass production controls.



MCL640 Series Thermal Imaging Camera

- Temperature ranges between -40 and 1600 °C
- Application specific wavelengths of 8 to 14 μm
- 60 frames per second
- User-friendly analysis programs and report generators (offline) as well as analysis and process control (online)



MCS640 Thermal Imaging Camera

- Temperature ranges between 600 and 3000°C
- Application-specific wavelength of 0.85 μm (through clean flame only)
- 60 frames per second
- User-friendly analysis programs and report generators (offline) as well as analysis and process control (online)

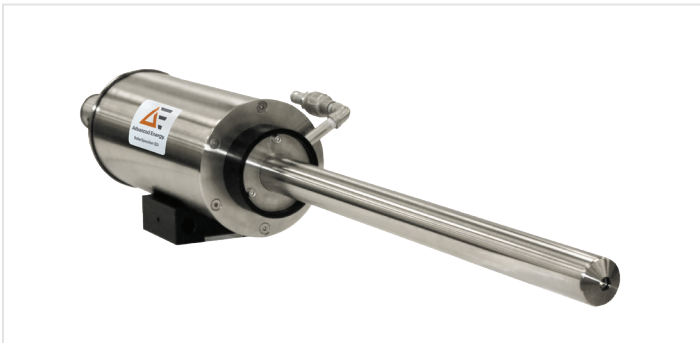

FurnaceSpection™

FurnaceSpection is designed to continuously monitor through natural flames, the temperature of the liquid glass, and refractory inside the melt tank. This system helps operators monitor and control process temperature uniformity through streaming images and powerful software for analysis and historical trending.

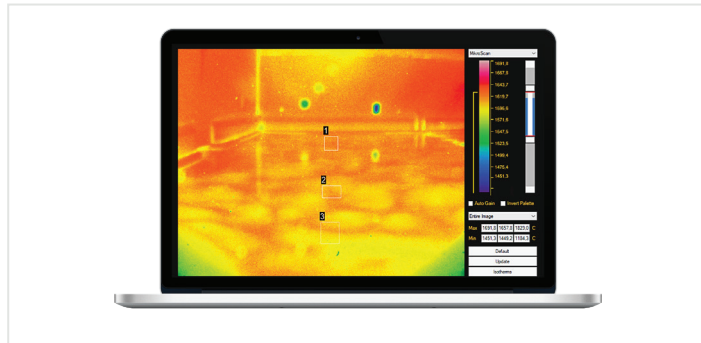

LumaSpec™ RT

Windows-based thermal imaging software that offers high-speed, real-time data acquisition and image analysis capabilities.

Thyro-Family of SCR Power Controllers

No other SCR power controller series offers the flexibility and performance of Advanced Energy’s Thyro-Family line.



Thyro-PX® Series

Built for demanding thermal applications, our high-performance Thyro-PX SCR power controller supports not only multiple operating voltages and control modes but also load currents up to 5000 A.

- Large 71.1 mm (2.8 in) LED graphic display with integrated process data recorder and SD card
- Digital and analog I/O options with integrated memory for error tracking and energy consumption
- Mains load optimization with dynamic digital control and power monitoring



Thyro-A+ Series

With an optional display and increased measuring accuracy, the Thyro-A+ precise, digital SCR power controller series offers comprehensive operating and control modes to save system costs for resistive and transformer loads in various applications.

- Increase performance control accuracy to maximize end process repeatability
- Easy fieldbus integration with integrated Modbus RTU interface or optional BasicBusModule

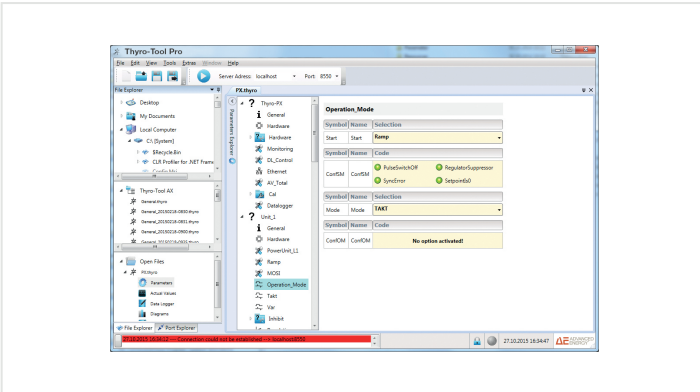

Thyro Tool Software

Thyro-Tool software is custom PC software made for all SCR power controllers.

- Commissioning, visualization, and diagnosis of SCR power controllers
- Individual analysis for each connected SCR power controller (system driven via IP address)
- Simultaneous presentation of process data of several power controllers

Plasma Power Generators

Power delivery solutions designed for stability, fast arc detection, and low arc energy that is necessary to improve the throughput and yield of your glass coating processes.



Ascent® AMS Series

Stable Power Delivery for Extreme Arc Conditions and Highly Repeatable Films.

Advanced Energy's front-line DC generator provides performance and reliability required in dual-magnetron sputtering applications.

- Arcs are actively managed, versus a generic pre-set arc response
 - Less than 0.4 mJ per 1 kW of output energy
 - Stable, repeatable process through arcing conditions
- Primary/Secondary for high power applications
- Higher power levels with reduced arc damage



Ascent® DMS Series

Advanced Dual-Magnetron Sputtering Accessories.

A field-proven solution for any dual-magnetron sputtering application with additional capabilities facilitating advanced process innovation.

- Achieve higher deposition rates with a more stable process through advanced ARC management
- Tune your process with variable frequency and duty cycle
- Tailor to your system requirements: 30, 40, and 60 kW units configurable up to 180 kW



Ascent® AP Series

Unprecedented Power Control for Single- and Dual-Magnetron Sputtering

Achieve new levels of process performance using field-proven, bipolar DC pulsing technology.

- Advanced waveform control allows process fine-tuning
- Available for both dual-pulsed and single-pulsed magnetron sputtering applications
- Compact design incorporates DC and pulsing

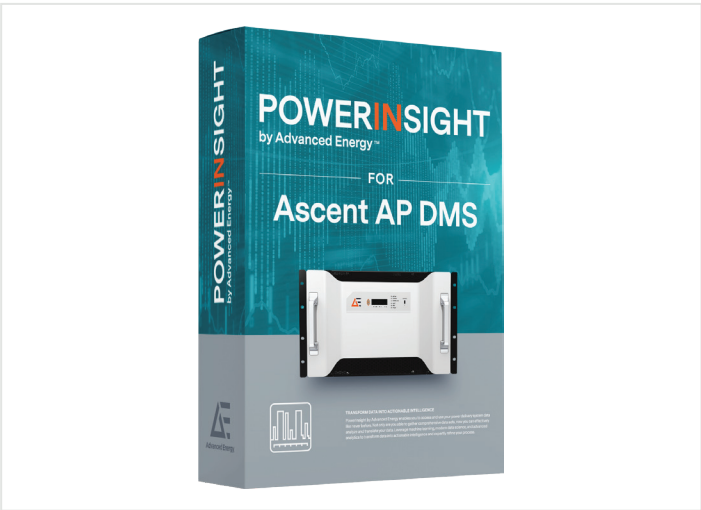

PowerInsight

PowerInsight by Advanced Energy™ enables you to gather comprehensive data sets to effectively analyze and translate your data. Leverage machine learning, modern data science, and advanced analytics to transform data into actionable intelligence and expertly refine your process.

- Improve yield and reduce unplanned downtime with advanced analytics
- Leverage decades of AE power delivery expertise with enriched and contextualized data sets
- Supplement your existing systems with focused power delivery diagnostics that can enable AI solutions

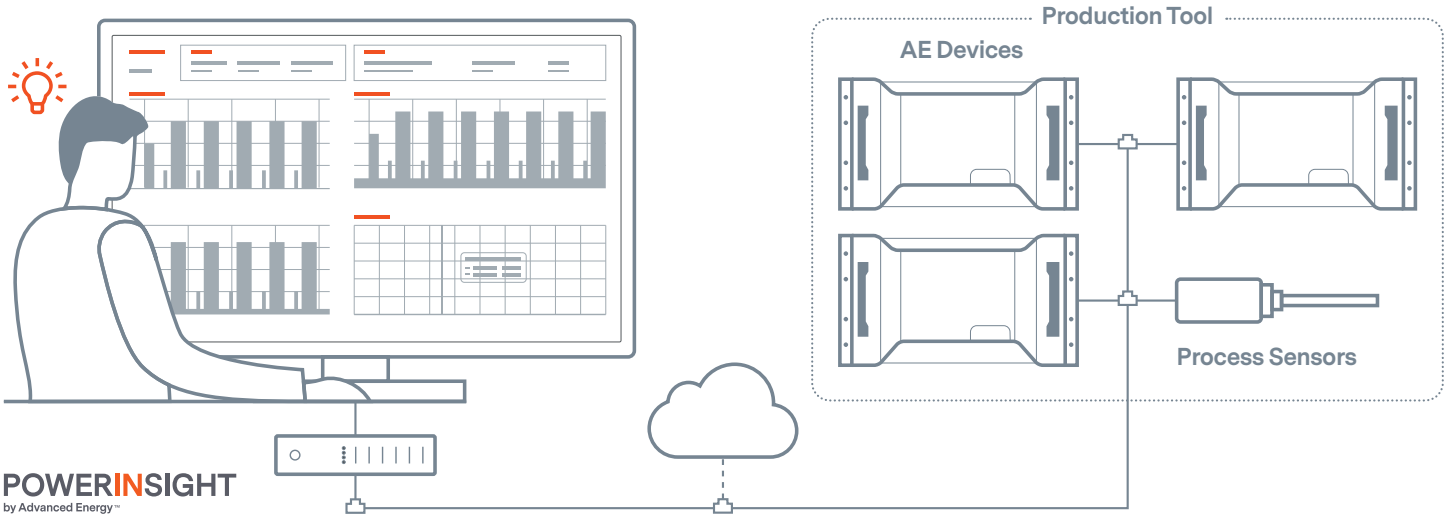

POWERINSIGHT
by Advanced Energy™



For international contact information,
visit advancedenergy.com

sales.support@aei.com
+1 970 221 0108

ABOUT ADVANCED ENERGY

Advanced Energy has devoted more than three decades to perfecting power for its global customers. We design and manufacture highly engineered, precision power conversion, measurement and control solutions for mission-critical applications and processes.

Our products enable customer innovation in complex applications for a wide range of industries including semiconductor equipment, industrial, manufacturing, telecommunications, data center computing, and medical.

With deep applications know-how and responsive service and support across the globe, we build collaborative partnerships to meet rapid technological developments, propel growth for our customers, and innovate the future of power.

PRECISION | POWER | PERFORMANCE | TRUST

©2023 Advanced Energy Industries, Inc. All rights reserved. Advanced Energy®, Impac®, Thyro-PX®, FurnaceSpection™, LumaSpec™, Ascent®, PowerInsight by Advanced Energy™ are trademarks of Advanced Energy Industries, Inc.