

ARTESYN AVO200-48S12 SERIES

200 Watts 1/8 Brick Converter



PRODUCT DESCRIPTION

Advanced Energy's Artesyn AVO200-48S12 series is a single output DC/DC converter with standard eighth-brick form factor and pin configuration. It delivers up to 16.7A output current with 12V output. Ultra-high 94% efficiency and excellent thermal performance makes it an ideal choice to supply power in datacom and telecommunication applications. It can operate over an ambient temperature range of -40°C to +85°C.

SPECIAL FEATURES

- Delivering up to 16.7A output
- Ultra-high efficiency 94% typ. at full load
- Wide input range: 36V to 75V
- Excellent thermal performance
- No minimum load requirement
- Basic isolation
- High power density
- Low output noise
- Reflow soldering-able
- RoHS 6 compliant
- Remote control function (negative logic)
- Remote output sense
- Trim function: 80% to 110%
- Input under voltage lockout
- Output over current protection
- Output short protection
- Output over voltage protection
- Over temperature protection
- Industry standard eighth-brick pin-out outline

SAFETY

- EN 62368-1
- UL/CSA 60950
- CE Mark
- 2006/95/EEC
- UL/TUV

TYPICAL APPLICATIONS

- Datacom
- Telecommunication

AT A GLANCE

Total Power

200 Watts

Input Voltage

36 to 75 Vdc

of Outputs

Single



MODEL NUMBERS

Standard	Output Voltage	Structure	Remote ON/OFF logic	RoHS Status
AVO200-48S12-6L	12Vdc	Open-frame	Negative	R6
AVO200-48S12B-6L	12Vdc	Baseplate	Negative	R6

Order Information

AVO200	-	48	S	12	P	B	-	6	L
①		②	③	④	⑤	⑥		⑦	⑧

①	Model series	AVO: high efficiency eighth-brick series, 200: output power 200W
②	Input voltage	48: 36V ~ 75V input range, rated input voltage 48V
③	Output number	S: single output
④	Rated output voltage	12: 12V output
⑤	Remote ON/OFF logic	Default: negative logic; P: positive logic
⑥	Baseplate	B: with baseplate; default: open frame
⑦	Pin length	6: 3.8mm pin length S: SMT pin T: SMT pin and tape reel package
⑧	RoHS status	L: RoHS, R6

Options

None

ELECTRICAL SPECIFICATIONS

Absolute Maximum Ratings

Stress in excess of those listed in the “Absolute Maximum Ratings” may cause permanent damage to the power supply. These are stress ratings only and functional operation of the unit is not implied at these or any other conditions above those given in the operational sections of this TRN. Exposure to any absolute maximum rated condition for extended periods may adversely affect the power supply’s reliability.

Table 1. Absolute Maximum Ratings						
Parameter	Model	Symbol	Min	Typ	Max	Unit
Input Voltage Operating -Continuous Non-operating -100mS	All	$V_{IN,DC}$	-	-	80	Vdc
	All		-	-	100	Vdc
Maximum Output Power	All	$P_{O,max}$	-	-	200	W
Ambient Operating Temperature	All	T_A	-40	-	+85	°C
Storage Temperature	All	T_{STG}	-55	-	+125	°C
Voltage at remote ON/OFF pin	All		-0.7	-	5	Vdc
Humidity (non-condensing) Operating Non-operating	All		-	-	95	%
	All		-	-	95	%

ELECTRICAL SPECIFICATIONS

Input Specifications

Table 2. Input Specifications						
Parameter	Condition ¹	Symbol	Min	Typ	Max	Unit
Operating Input Voltage, DC	All	$V_{IN,DC}$	36	48	75	Vdc
Turn-on Voltage Threshold	$I_O = I_{O,max}$	$V_{IN,ON}$	31	-	36	Vdc
Turn-off Voltage Threshold	$I_O = I_{O,max}$	$V_{IN,OFF}$	30	-	35	Vdc
Lockout Voltage Hysteresis	$I_O = I_{O,max}$		1	-	3	V
Maximum Input Current ($I_O = I_{O,max}$)	$V_{IN,DC} = 36Vdc$	$I_{IN,max}$	-	-	7.5	A
Recommended Input Fuse	Fast blow external fuse recommended		-	-	12	A
Recommended External Input Capacitance	Low ESR capacitor recommended	C_{IN}	220	-	-	μF
Input Reflected Ripple Current	Through 12 μH inductor		-	-	60	mA
Operating Efficiency	$T_A = 25^\circ C$ $I_O = 50\% I_{O,max}$ $I_O = 100\% I_{O,max}$	η	-	93.5 94	-	% %

Note 1 - $T_A = 25^\circ C$, airflow rate = 400 LFM, $V_{in} = 48Vdc$, nominal V_{out} unless otherwise indicated.

ELECTRICAL SPECIFICATIONS

Output Specifications

Table3. Output Specifications							
Parameter	Condition ¹	Symbol	Min	Typ	Max	Unit	
Factory Set Voltage	$V_{IN,DC} = 48Vdc$ $I_O = I_{O,max}$	V_O	11.7	12	12.2	Vdc	
Total Regulation	Inclusive of line, load temperature change, warm-up drift	V_O	11.7	12	12.2	Vdc	
Output Voltage Line Regulation	All	$\%V_O$	-	-	0.4	%	
Output Voltage Load Regulation	All	$\%V_O$	-	-	0.4	%	
Output Voltage Temperature Regulation	All	$\%V_O$	-	-	0.02	%/°C	
Output Voltage Trim Range	All	V_O	9.6	-	13.2	V	
Output Ripple, pk-pk	Measure with a 1uF ceramic capacitor in parallel with a 10uF tantalum capacitor, 0 to 20MHz bandwidth	V_O	-	70	-	mV _{PK-PK}	
Output Current	All	I_O	0	-	16.7	A	
Output DC current-limit inception ²		I_O	18.5	-	24.0	A	
V_O Load Capacitance ³	All	C_O	220	-	5000	uF	
V_O Dynamic Response	Peak Deviation Settling Time	25% load change slew rate = 0.1A/us	$\pm V_O$	-	60	-	mV
		T_s	-	200	-	uSec	
		25% load change slew rate = 1A/us	$\pm V_O$	-	80	-	mV
			T_s	-	200	-	uSec
Turn-on transient	Rise time	$I_O = I_{O,max}$	T_{rise}	-	-	50	mS
	Turn-on delay time	$I_O = I_{O,max}$	$T_{turn-on}$	-	-	100	mS
	Output voltage overshoot	$I_O = 0$	$\%V_O$	-	-	5	%
Isolation Voltage	Input to output	1mA for 60s Slew rate of 1500V/10s		2250	-	-	Vdc
Switching frequency	All	f_{sw}	-	150	-	KHz	
Remote ON/OFF control (positive logic)	Off-state voltage	All		-0.7	-	1.2	V
	On-state voltage	All		3.5	-	5	V

Note 1 - $T_a = 25\text{ }^\circ\text{C}$, airflow rate = 400 LFM, $V_{in} = 48Vdc$, nominal V_{out} unless otherwise indicated.

Note 2 - Hiccup: auto-restart when over-current condition is removed.

Note 3 - High frequency and low ESR is recommended.

ELECTRICAL SPECIFICATIONS

Output Specifications

Table3.Output Specifications,con't							
Parameter		Condition	Symbol	Min	Typ	Max	Unit
Remote ON/OFF control (Negative logic)	Off-state voltage	All		3.5	-	5	V
	On-state voltage	All		-0.7	-	1.2	V
Output over-voltage protection ⁴		All	V _O	13.6	-	17	%
Output over-temperature protection ⁵		All	T	85	110	125	°C
With baseplate				110	121	135	°C
Over-temperature hysteresis		All	T	-	5	-	°C
+ Sense		All	%V _O	-	-	5	%
- Sense		All	%V _O	-	-	5	%
MTBF		Telcordia SR-332-2006; 80% load, 300LFM, 40 °C T _a		-	1.5	-	10 ⁶ h

Note 4 - Hiccup: auto-restart when over-voltage condition is removed.

Note 5 - Auto recovery.

ELECTRICAL SPECIFICATIONS

AVO200-48S12-6L Performance Curves

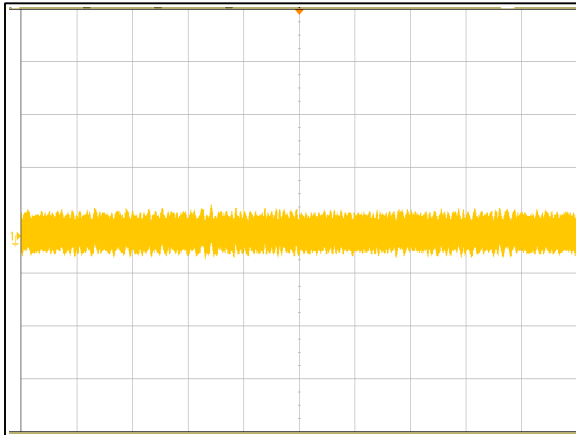

Figure 1: AVO200-48S12-6L Input Reflected Ripple Current Waveform
 Vin = 48Vdc Load: Io = 16.7A
 Ch 1: Iin (50uS/div, 50mA/div)

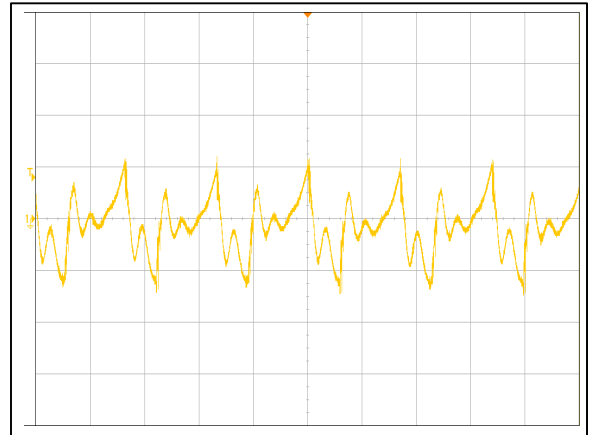

Figure 2: AVO200-48S12-6L Ripple and Noise Measurement
 Vin = 48Vdc Load: Io = 16.7A
 Ch 1: Vo (2us/div, 20mV/div)

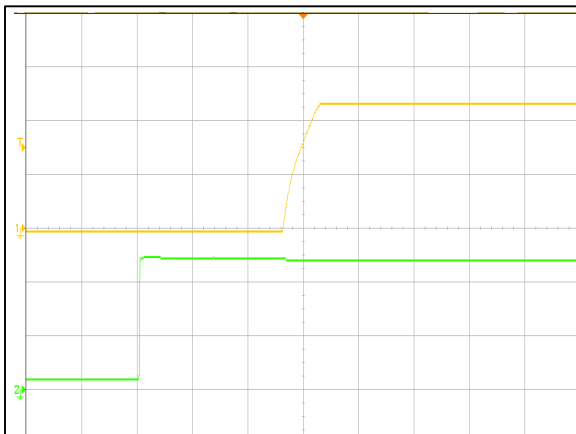

Figure 3: AVO200-48S12-6L Output Voltage Startup Characteristic
 Vin = 36Vdc Load: Io = 16.7A (2mS/div)
 Ch 1: Vo (2V/div) Ch 2: Vin (20V/div)

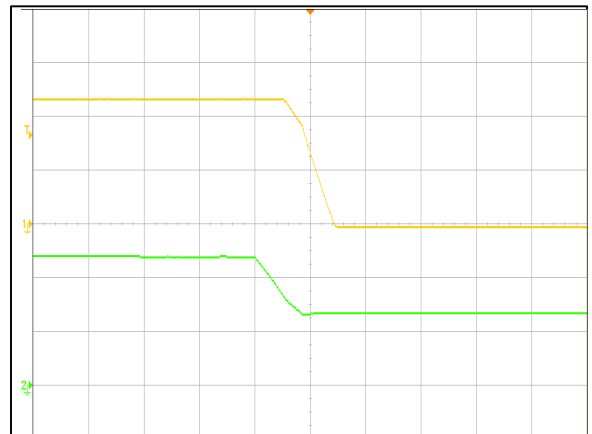

Figure 4: AVO200-48S12-6L Turn Off Characteristic (1mS/div)
 Vin = 36Vdc Load: Io = 16.7A
 Ch 1: Vo (2V/div) Ch 2: Vin (20V/div)

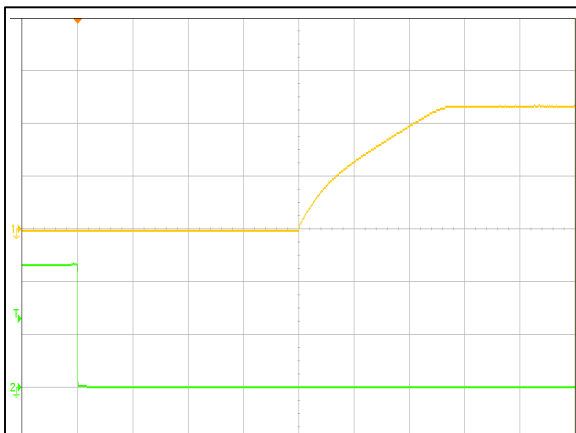

Figure 5: AVO200-48S12-6L Remote ON Waveform (50mS/div)
 Vin = 36Vdc Load: Io = 16.7A
 Ch 1: Vo (5V/div) Ch 2: Remote ON (2V/div)

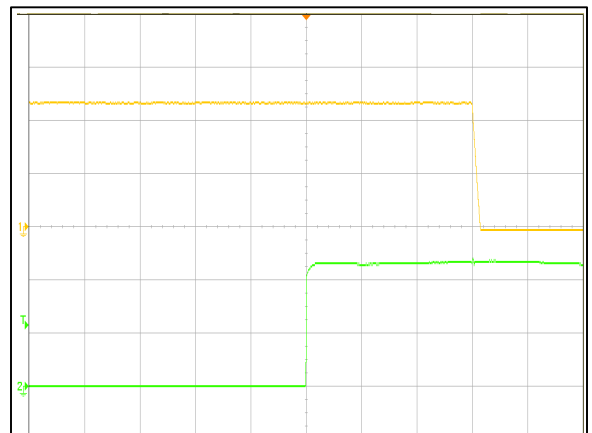

Figure 6: AVO200-48S12-6L Remote OFF Waveform (20mS/div)
 Vin = 36Vdc Load: Io = 16.7A
 Ch 1: Vo (5V/div) Ch 2: Remote OFF (2V/div)

ELECTRICAL SPECIFICATIONS

AVO200-48S12-6L Performance Curves

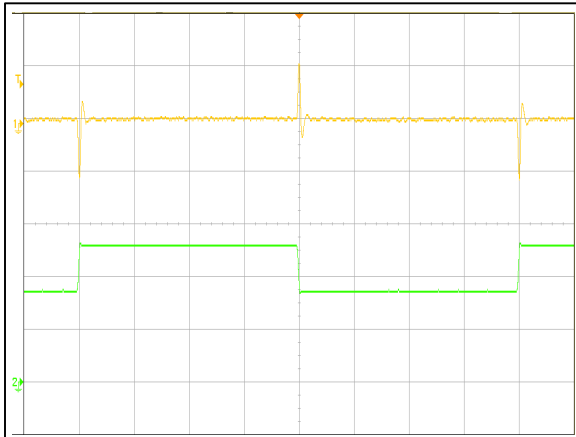

Figure 7: AVO200-48S12-6L Transient Response (1mS/div)
 50%~75%~50% load change, 0.1A/uS slew rate, Vin = 48Vdc
 Ch 1: Vo (50mV/div) Ch 2: Io (5A/div)

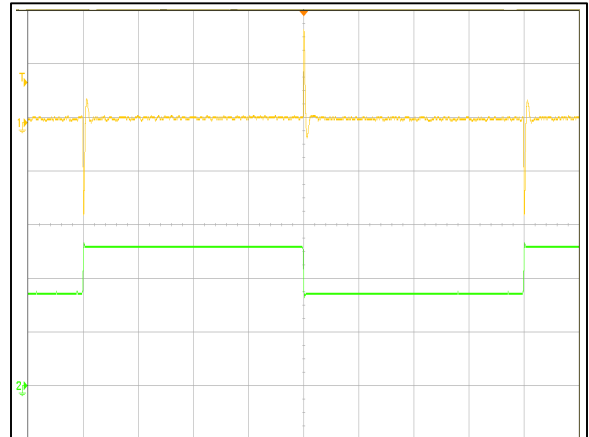

Figure 8: AVO200-48S12-6L Transient Response (1mS/div)
 50%~75%~50% load change, 1A/uS slew rate, Vin = 48Vdc
 Ch 1: Vo (50mV/div) Ch 2: Io (5A/div)

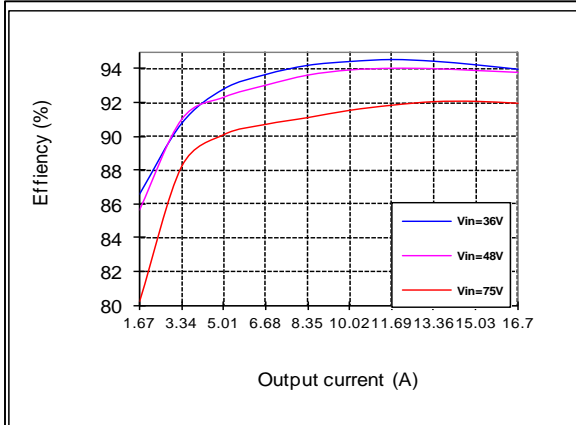

Figure 9: AVO200-48S12-6L Efficiency Curves @ 25 degC
 Loading: Io = 10% increment to 16.7A

ELECTRICAL SPECIFICATIONS

AVO200-48S12B-6L Performance Curves

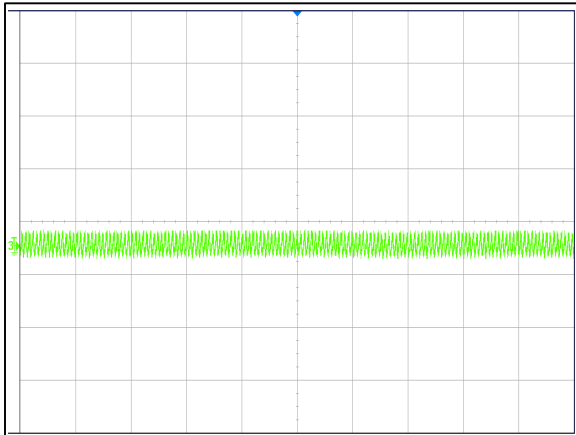

Figure 10: AVO200-48S12B-6L Input Reflected Ripple Current Waveform
 Vin = 48Vdc Load: Io = 16.7A
 Ch 3: Iin (50uS/div, 50mA/div)

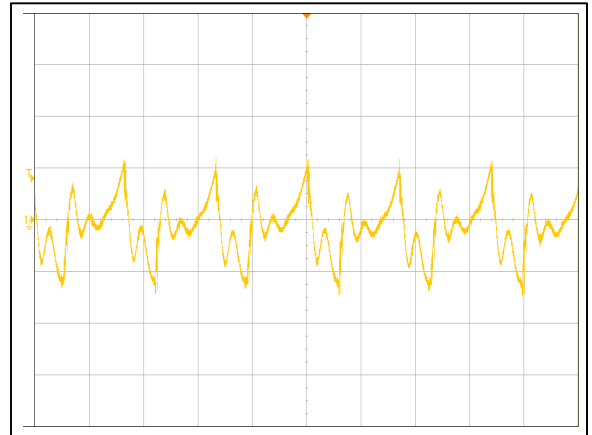

Figure 11: AVO200-48S12B-6L Ripple and Noise Measurement
 Vin = 48Vdc Load: Io = 16.7A
 Ch 1: Vo (2us/div, 20mV/div)

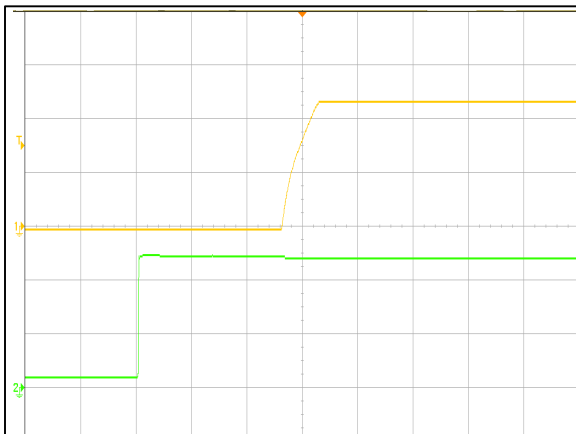

Figure 12: AVO200-48S12B-6L Output Voltage Startup Characteristic
 Vin = 36Vdc Load: Io = 16.7A (2mS/div)
 Ch 1: Vo (5V/div) Ch 2: Vin (20V/div)

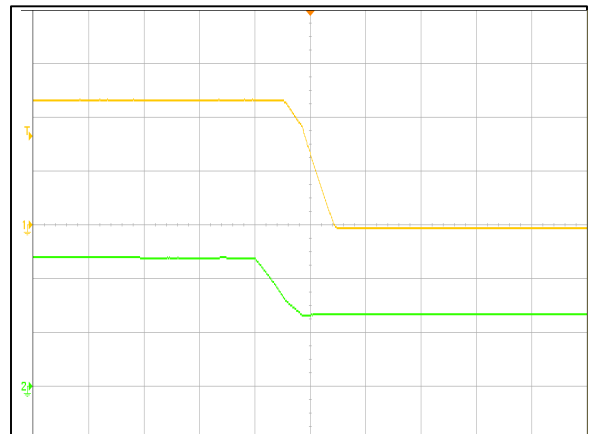

Figure 13: AVO200-48S12B-6L Turn Off Characteristic (1mS/div)
 Vin = 36Vdc Load: Io = 16.7A
 Ch 1: Vo (5V/div) Ch 2: Vin (20V/div)

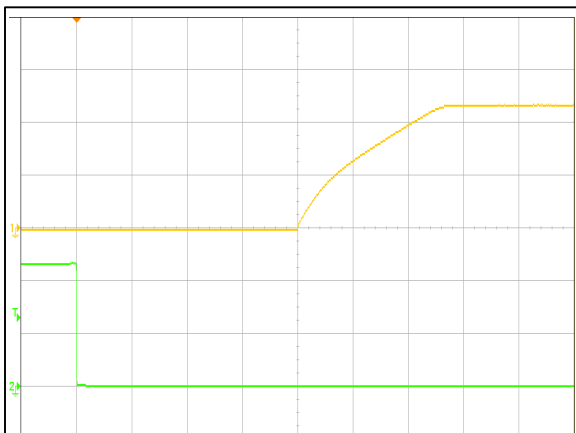

Figure 14: AVO200-48S12B-6L Remote ON Waveform (5mS/div)
 Vin = 36Vdc Load: Io = 16.7A
 Ch 1: Vo (5V/div) Ch 2: Remote ON (2V/div)

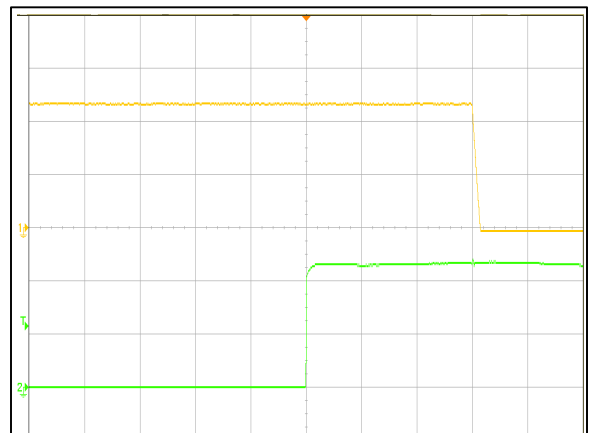

Figure 15: AVO200-48S12B-6L Remote OFF Waveform (5mS/div)
 Vin = 36Vdc Load: Io = 16.7A
 Ch 1: Vo (5V/div) Ch 2: Remote OFF (3V/div)

ELECTRICAL SPECIFICATIONS

AVO200-48S12B-6L Performance Curves

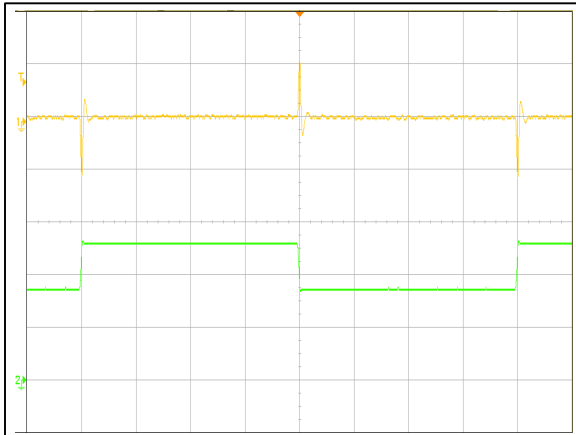

Figure 16: AVO200-48S12B-6L Transient Response (1mS/div)
 50%~75%~50% load change, 0.1A/uS slew rate, Vin = 48Vdc
 Ch 1: Vo (50mV/div) Ch 2: Io (5A/div)

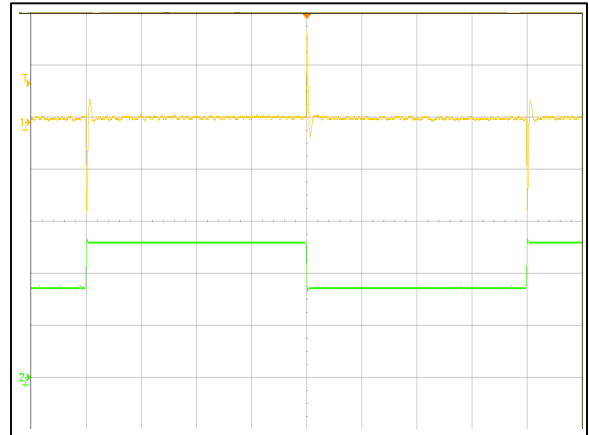

Figure 17: AVO200-48S12B-6L Transient Response (1mS/div)
 50%~75%~50% load change, 1A/uS slew rate, Vin = 48Vdc
 Ch 1: Vo (50mV/div) Ch 2: Io (5A/div)

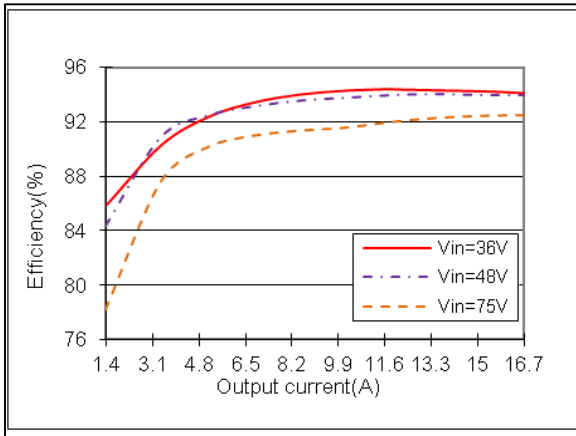
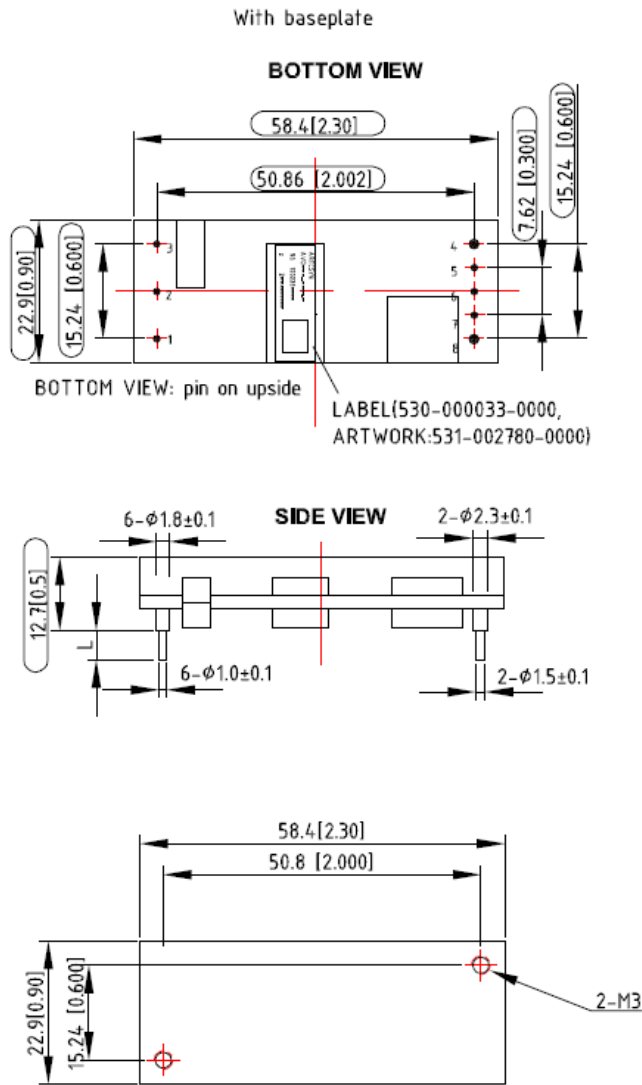

Figure 18: AVO200-48S12B-6L Efficiency Curves @ 25 degC
 Loading: Io = 10% increment to 16.7A

MECHANICAL SPECIFICATIONS

Mechanical Outlines - Baseplate Module (unit: mm)

AVO200-48S12B-6L



Note: Depth penetration into base plate, of M3 screws used at baseplate mounting holes, not to exceed maximum of 3.0mm.

MECHANICAL SPECIFICATIONS

Mechanical Outlines - Open Frame Module (unit: mm)

AVO200-48S12-6L

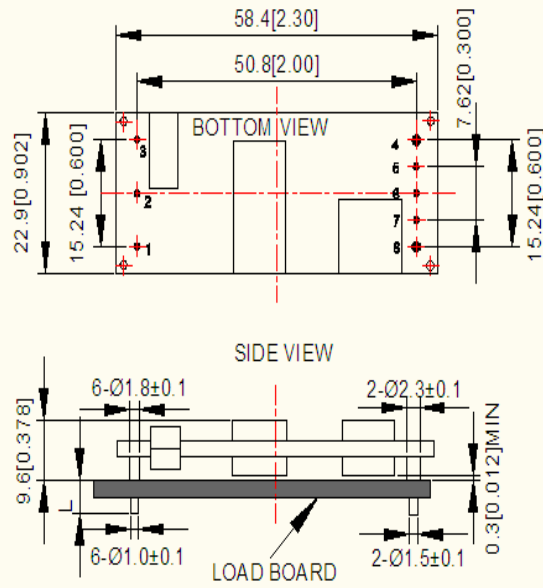

UNIT: mm[inch] BOTTOM VIEW: pin on upside
 TOLERANCE: X.Xmm±0.5mm[X.X in.±0.02in.]
 X.XXmm±0.25mm[X.XX in.±0.01in.]

MECHANICAL SPECIFICATIONS

Pin Length Option

Device code suffix	L
-4	4.8mm±0.25 mm
-6	3.8mm±0.25 mm
-8	2.8mm±0.25 mm
None	5.8mm±0.25 mm

Pin Designations

Pin No	Name	Function
1	Vin+	Positive input voltage
2	Remote On/Off	ON/OFF control terminal
3	Vin-	Negative input voltage
4	Vo-	Negative output voltage
5	S-	Negative remote sense
6	Trim	Output voltage trim
7	S+	Positive remote sense
8	Vo+	Positive output voltage

MECHANICAL SPECIFICATIONS

Weight

The AVO200-48S12 series weight is 35g. maximum.

ENVIRONMENTAL SPECIFICATIONS

EMC Immunity

AVO200-48S12 series power supply is designed to meet the following EMC immunity specifications:

Table 4. Environmental Specifications		
Document	Description	Criteria
EN55032, Class A Limits	Conducted Emission	A
IEC/EN 61000-4-2, Level 3	Immunity to Electrostatic Discharge	B
IEC/EN 61000-4-6, Level 2	Immunity to Continuous Conducted Interference	A
IEC/EN 61000-4-4, Level3	Immunity to Electrical Fast Transient	B
IEC/EN 61000-4-5	Immunity to Surges	B
EN61000-4-29	Immunity to Voltage Dips and Short Interruptions and Voltage Variations	B

Criterion A: Normal performance during and after test.

Criterion B: For EFT and surges, low-voltage protection or reset is not allowed. Temporary output voltage fluctuation ceases after the disturbances ceases, and from which the EUT recovers its normal performance automatically. For dips and ESD, output voltage fluctuation or reset is allowed during the test, but recovers to its normal performance automatically after the disturbance ceases.

Criterion C: Temporary loss of output, the correction of which requires operator intervention.

Criterion D: Loss of output which is not recoverable, owing to damage to hardware.

EMC Test Conditions

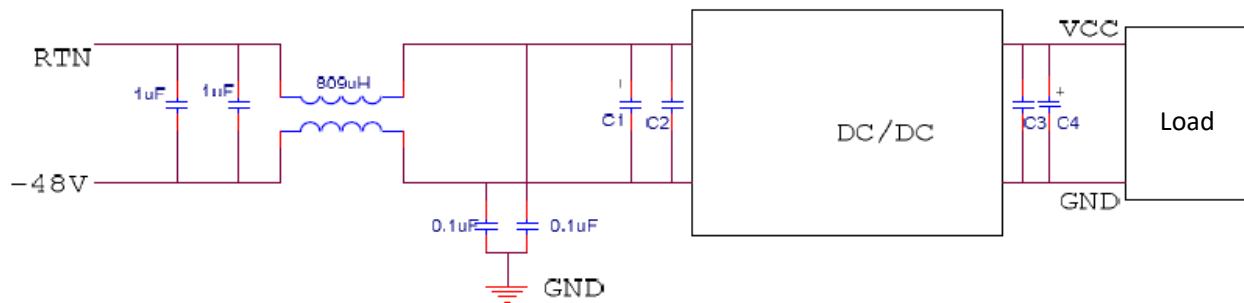

Figure 19 EMC test configuration

C1 ~ C4: See Figure 26.

ENVIRONMENTAL SPECIFICATIONS

EMI Emissions

The AVO200-48S12 series has been designed to comply with the Class A limits of EMI requirements of EN55032 (FCC Part 15) and CISPR 22 (EN55032) for emissions and relevant sections of EN61000 (IEC 61000) for immunity. The unit is enclosed inside a metal box, tested at 200W using resistive load.

Conducted Emissions

The applicable standard for conducted emissions is EN55032 (FCC Part 15). Conducted noise can appear as both differential mode and common mode noise currents. Differential mode noise is measured between the two input lines, with the major components occurring at the supply fundamental switching frequency and its harmonics. Common mode noise, a contributor to both radiated emissions and input conducted emissions, is measured between the input lines and system ground and can be broadband in nature.

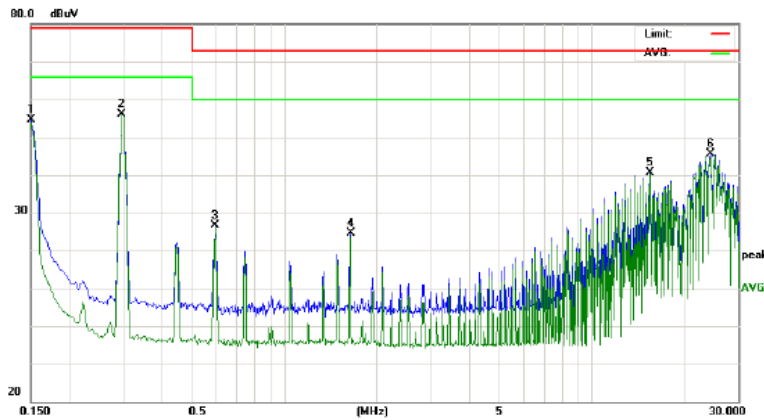

The AVO200-48S12 power supplies have internal EMI filters to ensure the converters' conducted EMI levels comply with EN55032 (FCC Part 15) Class A and EN55032 (CISPR 22) Class A limits. The EMI measurements are performed with resistive loads at maximum rated loading.

Sample of EN55032 Conducted EMI Measurement at 36Vdc input

Note: Red Line refers to Artesyn Quasi Peak margin, which is 6dB below the CISPR international limit. Green Line refers to the Artesyn Average margin, which is 6dB below the CISPR international limit.

Conducted Emissions

Table 5. Conducted EMI emission specifications of the AVO200-48S12 series						
Parameter	Model	Symbol	Min	Typ	Max	Unit
FCC Part 15, class A	All	Margin	-	-	6	dB
CISPR 22 (EN55032) class A	All	Margin	-	-	6	dB

ENVIRONMENTAL SPECIFICATIONS

Safety Certifications

The AVO200-48S12 power supply is intended for inclusion in other equipment and the installer must ensure that it is in compliance with all the requirements of the end application. This product is only for inclusion by professional installers within other equipment and must not be operated as a stand alone product.

Table 6. Safety Certifications for AVO200-48S12 series module

Document	Agency	Description
UL/CSA 62368-1	UL+CUL	US and Canada Requirements
EN62368-1	TUV	European Requirements
IEC62368-1	IEC	International Requirements
CE	CE	CE Marking

ENVIRONMENTAL SPECIFICATIONS

Operating Temperature

The AVO200-48S12 series power supplies will start and operate within stated specifications at an ambient temperature from -40 °C to 85 °C under all load conditions. The storage temperature is -55 °C to 125 °C.

Thermal Considerations – Open-frame module

The converter is designed to operate in different thermal environments and sufficient cooling must be provided. Proper cooling of the DC/DC converter can be verified by measuring the temperature at the test point as shown in the Figure 20. The temperature at this point should not exceed the max values in the table 7.

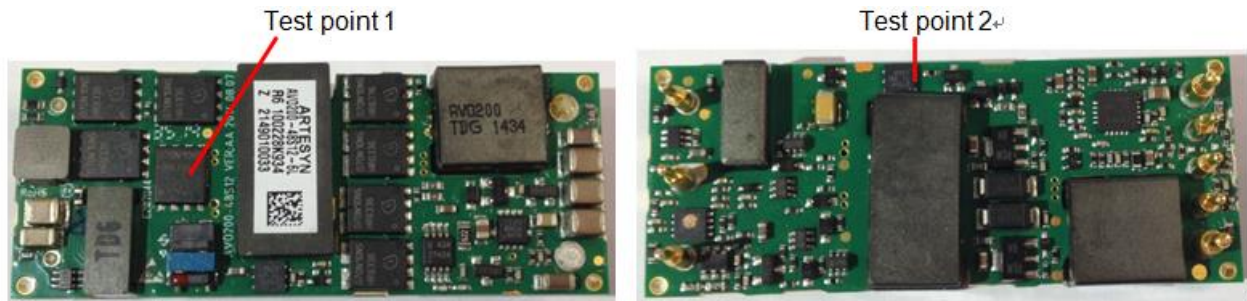

Figure 20 Temperature test point

Table 7. Temperature limit of the test point	
Test Point	Temperature Limit
Test point 1	130 °C
Test point 2 (PCB)	120 °C

For a typical application, figure 21 shows the derating of output current vs. ambient air temperature at different air velocity.

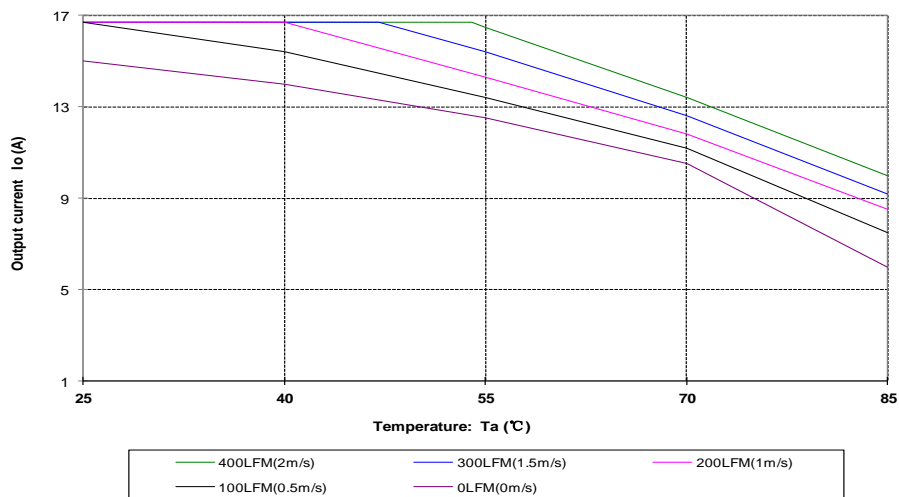

Figure 21 Output power derating, 48Vin, air flowing across the converter from pin 3 to pin 1

ENVIRONMENTAL SPECIFICATIONS

Thermal Considerations –Base plate module

The converter can both operate in two different modes.

Mode 1: The converter can operate in a enclosed environment without forced air convection. Cooling of the converter is achieved mainly by conduction from the baseplate to a heat sink. The converter can deliver full output power at 85°C ambient temperature provided the baseplate temperature is kept the max values 100°C.

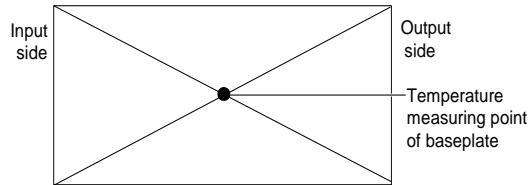

Figure 22 Temperature test point on base plate

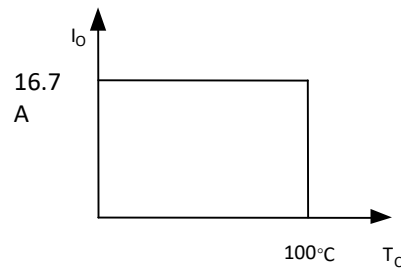
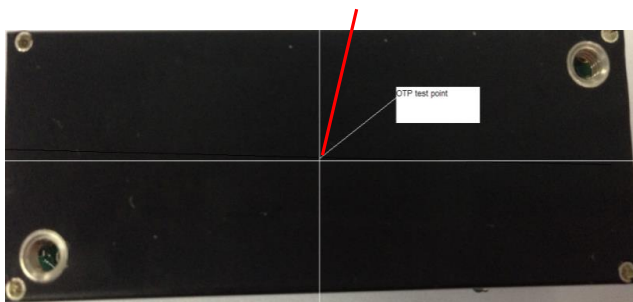

Figure 23 Output power derating curve, T_c: temperature test point on baseplate, see Figure 15

Mode 2: The converter is designed to operate in different thermal environments and sufficient cooling must be provided. Proper cooling of the DC/DC converter can be verified by measuring the temperature at the test point as shown in the Figure20. The temperature at this point should not exceed the max values in the table 8.

Test point on base plate



Test point on PCB

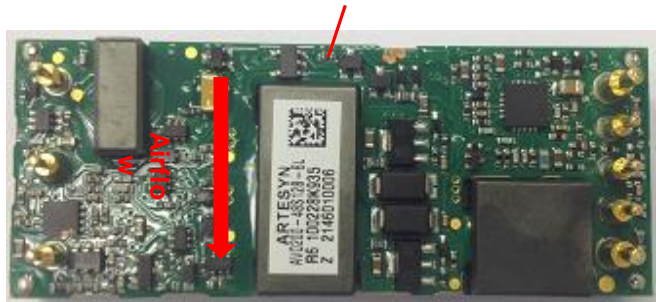

ENVIRONMENTAL SPECIFICATIONS

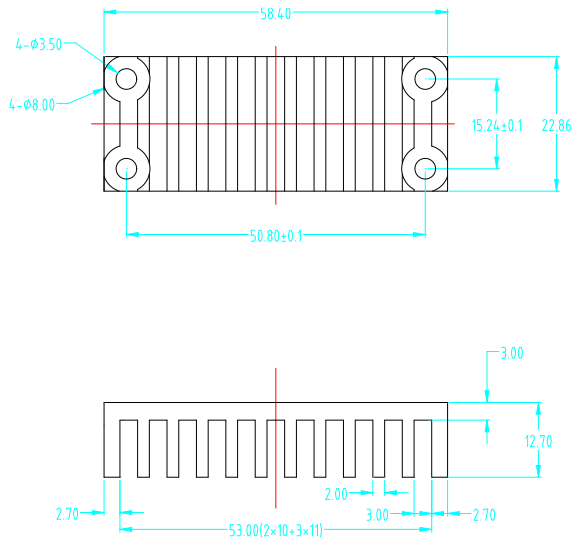

Figure 24 Temperature test point & heat sink mechanical diagram

Table8. Temperature limit of the test point	
Test Point	Temperature Limit
Test point on PCB	109 °C
Test point on base plate	118 °C

For a typical application, figure 25 shows the derating of output current vs. ambient air temperature at different air velocity.

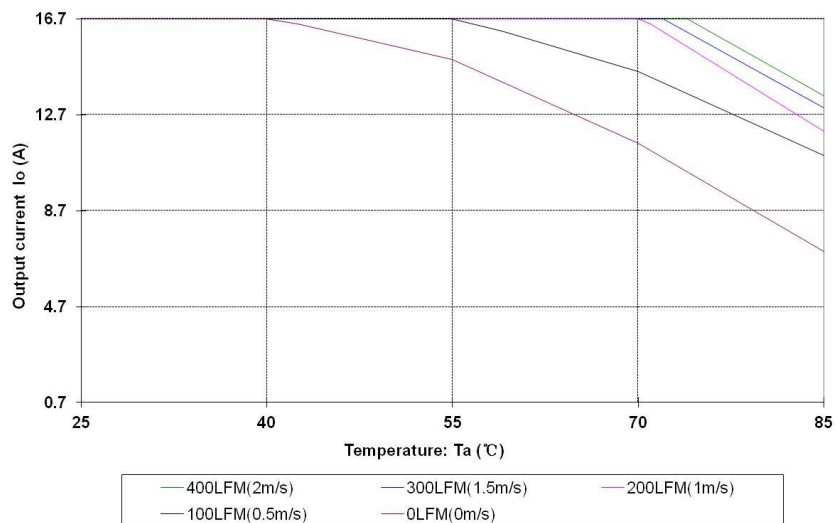

Figure 25 Output power derating, 48Vin, air flowing across the converter (from pin 3 to pin1)

ENVIRONMENTAL SPECIFICATIONS

Qualification Testing

Parameter	Unit (pcs)	Test condition
Halt test	4-5	$T_{a,min} - 30\text{ }^{\circ}\text{C}$ to $T_{a,max} + 25\text{ }^{\circ}\text{C}$, $10\text{ }^{\circ}\text{C}$ step, V_{in} = min to max, $0 \sim 100\%$ load
Vibration	3	Frequency range: $5\text{ Hz} \sim 20\text{ Hz}$, $20\text{ Hz} \sim 200\text{ Hz}$, A.S.D: $1.0\text{ m}^2/\text{s}^3$, -3 db/oct , axes of vibration: X/Y/Z. Time: 30min/axes
Mechanical Shock	3	30g, 6ms, 3axes, 6directions, 3time/direction
Thermal Shock	3	$-55\text{ }^{\circ}\text{C}$ to $125\text{ }^{\circ}\text{C}$, unit temperature 20cycles
Thermal Cycling	3	$-40\text{ }^{\circ}\text{C}$ to $85\text{ }^{\circ}\text{C}$, temperature change rate: $1\text{ }^{\circ}\text{C}/\text{min}$, cycles: 2cycles
Humidity	3	$40\text{ }^{\circ}\text{C}$, 95%RH, 48h
Solder Ability	15	IPC J-STD-002C-2007

APPLICATION NOTES

Typical Application

Below is the typical application of the AVO200 series power supply.

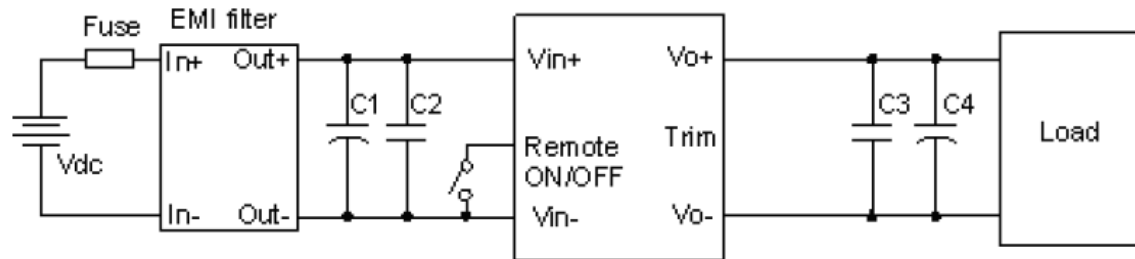

Figure 26 Typical application

C1: 220 μ F/100V electrolytic capacitor; P/N: UPM2A221MPD (Nichicon) or equivalent caps

C2, C3: 1 μ F/100V X7R ceramic capacitor, P/N: C3216X7R2A105KT0L0S (TDK) or equivalent caps

C4: 1000 μ F electrolytic capacitor, P/N: UPM1A102MHD (Nichicon) or equivalent caps

Fuse: External fast blow fuse with a rating of 12A. The recommended fuse model is 21612.5P from LITTLEFUSE.

APPLICATION NOTES

Remote ON/OFF

Negative remote ON/OFF logic is available in AVO200-48S12. The logic is CMOS and TTL compatible. The voltage between pin Remote ON/OFF and pin Vin- must not exceed the range listed in table 3 to ensure proper operation. The external Remote ON/OFF circuit is highly recommended as shown in figure 27.

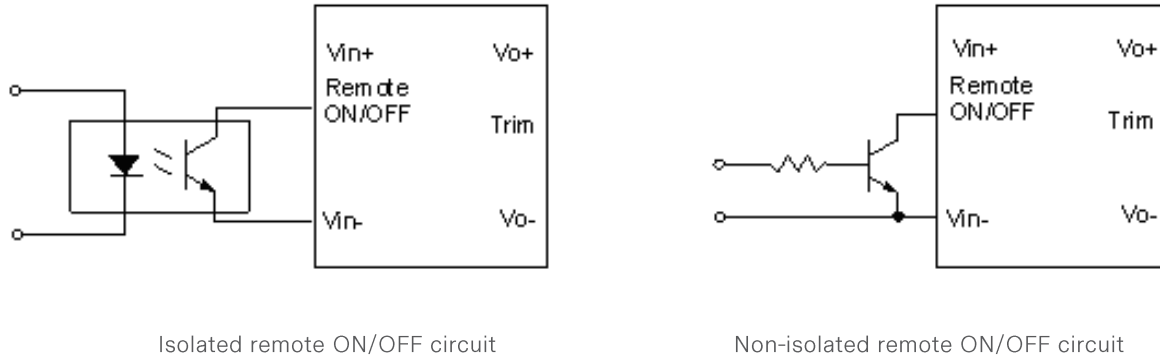

Figure 27 External Remote ON/OFF circuit

APPLICATION NOTES

Trim Characteristics

Connecting an external resistor between Trim pin and Vo- pin will decrease the output voltage. While connecting it between Trim and Vo+ will increase the output voltage. The following equations determine the external resistance to obtain the trimmed output voltage.

$$R_{adj-down} = \frac{510}{\Delta} - 10.2(K\Omega)$$

$$R_{adj-up} = \frac{5.1 \times V_{nom} \times (100 + \Delta)}{1.225 \times \Delta} - \frac{510}{\Delta} - 10.2(K\Omega)$$

Δ : Output error rate against nominal output voltage.

$$\Delta = \frac{100 \times (V_{nom} - V_0)}{V_{nom}}$$

V_{nom} : Nominal output voltage.

For example, to get 12.5V output, the trimming resistor is

$$\Delta = \frac{100 \times (V_{nom} - V_0)}{V_{nom}} = \frac{100 \times (12.5 - 12)}{12} = 4.167$$

$$R_{adj-up} = \frac{5.1 \times 12 \times (100 + 4.167)}{1.225 \times 4.167} - \frac{510}{4.167} - 10.2 = 1116.3(K\Omega)$$

When trimming up, the output current should be decreased accordingly so as not to exceed the maximum output power.

Internal side

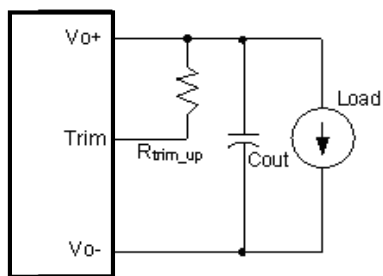

Figure 28 Trim up

Internal side

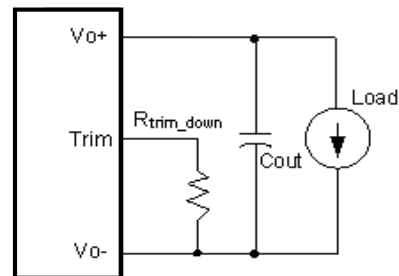

Figure 29 Trim down

APPLICATION NOTES

Input Ripple & Output Ripple & Noise Test Configuration

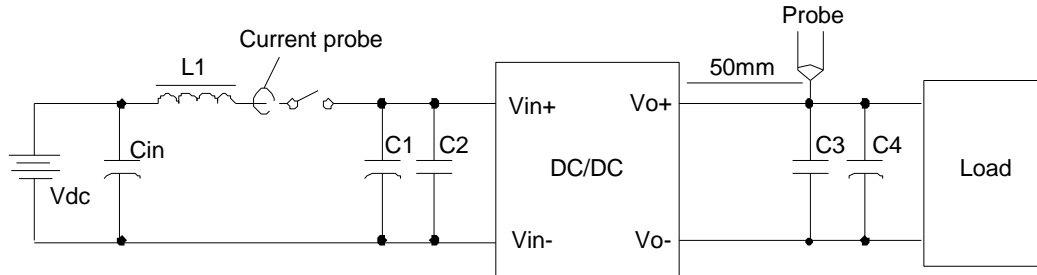

Figure 30 Input ripple & output ripple & noise test configuration

Vdc: DC power supply

L1: 12uH

Cin: 220uF/100V typical

C1 ~ C4: See Figure 26

Note - Using a coaxial cable with series 50ohm resistor and 0.68uF ceramic capacitor or a ground ring of probe to test output ripple & noise is recommended.

APPLICATION NOTES

Soldering

R6 Wave Soldering

The product is intended for standard manual or wave soldering.

When wave soldering is used, the temperature on pins is specified to maximum 260 °C for maximum 7s.

When soldering by hand, the iron temperature should be maintained at 300 °C ~ 380 °C and applied to the converter pins for less than 10s. Longer exposure can cause internal damage to the converter.

Cleaning of solder joint can be performed with cleaning solvent IPA or simulative.

Reflow soldering:

High temperature and long soldering time will result in IMC layer increasing in thickness and thereby shorten the solder joint lifetime. Therefore the peak temperature over 245 °C is not suggested due to the potential reliability risk of components under continuous high-temperature. In the meanwhile, the soldering time of temperature above 217 °C should be less than 90 seconds.

Please refer to following fig for recommended temperature profile parameters.

Shielding cap is requested to mount on DCDC module if with heat-spreader/heat-sink, to prevent the customer side high temperature of reflow to re-melt the DCDC module's internal component's soldering joint.

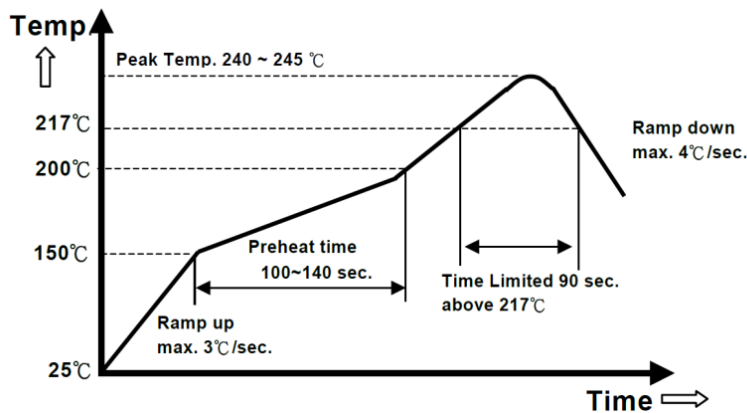

	Product Requirement	Remark	Product Name
R6	Reflow/Wave Soldering	12V	AVO200-48S12-6L
R6	Wave Soldering	12V	AVO200-48S12B-6L

RECORD OF REVISION AND CHANGES

Issue	Date	Description	Originators
1.0	01.28.2015	First Issue	D. Hou
1.1	06.16.2016	Update the mechanical drawing	K. Wang
1.2	10.25.2016	Update the error for soldering	K. Wang
1.3	10.23.2017	Update the C4 value from 220uF to 1000uF	A. Zhang
1.4	12.17.2019	Update the soldering part	C. Yan
1.5	05.26.2020	Update safety cert from 60950 to 62368-1	K. Wang



For international contact information,
visit advancedenergy.com.

powersales@aei.com (Sales Support)
productsupport.ep@aei.com (Technical Support)
+1 888 412 7832

ABOUT ADVANCED ENERGY

Advanced Energy (AE) has devoted more than three decades to perfecting power for its global customers. AE designs and manufactures highly engineered, precision power conversion, measurement and control solutions for mission-critical applications and processes.

Our products enable customer innovation in complex applications for a wide range of industries including semiconductor equipment, industrial, manufacturing, telecommunications, data center computing, and medical. With deep applications know-how and responsive service and support across the globe, we build collaborative partnerships to meet rapid technological developments, propel growth for our customers, and innovate the future of power.

PRECISION | POWER | PERFORMANCE

Specifications are subject to change without notice. Not responsible for errors or omissions. ©2020 Advanced Energy Industries, Inc. All rights reserved. Advanced Energy®, and AE® are U.S. trademarks of Advanced Energy Industries, Inc.